

From the Institute of Environmental Medicine,
Division of Work Environment Toxicology
Karolinska Institutet

Uptake, Disposition and Acute Effects of Inhaled Organic Solvents

**Sex differences and influence of
cytochrome P450 2E1 in human
volunteers**

Lena Ernstgård



Stockholm 2003

All previously published papers were reproduced with permission from the publisher,
Oxford University Press, Elsevier, and BMJ Publishing group

Published and printed by Karolinska University Press
Box 200, SE-171 77 Stockholm, Sweden
© Lena Ernstgård, 2003
ISBN 91-7349-657-X

*Bildning är inte vad vi lärt,
utan vad vi har kvar
när vi glömt allt vi lärt.*

Ellen Key

ABSTRACT

The main aim of the present thesis was to study the influence of sex, cytochrome P450 2E1 and chlorzoxazone on the uptake and metabolism of solvents in humans. Sex differences in acute effects of organic solvents were also assessed.

Study I: Many solvents, including acetone and toluene, are to a large extent metabolised by cytochrome P450 2E1 (CYP2E1). Also some pharmaceuticals such as chlorzoxazone are mainly metabolised by CYP2E1. Volunteers were exposed in an exposure chamber to acetone or toluene vapour at a dose equal to the Swedish occupational exposure limit, with and without intake of chlorzoxazone. The solvents were measured in inhaled air, exhaled air, capillary blood and urine. The levels of chlorzoxazone, its metabolite 6-hydroxychlorzoxazone and hippuric acid, a metabolite of toluene, were also measured. Chlorzoxazone intake did not result in significant effects on acetone or toluene disposition; however, we found indications of slightly decreased biotransformation of acetone and possibly also of toluene after intake of chlorzoxazone. In addition, both acetone and toluene seem to delay the metabolism of chlorzoxazone. The most likely explanation for the effect is competitive inhibition of CYP2E1.

Study II: To study the reliability of chlorzoxazone as an *in vivo* probe for CYP2E1 activity in humans, a series of experiments were performed. The influence of genotype, sampling time, dose, and ethanol intake were studied. In addition estimates of the intra- and inter-individual and short-term and long-term intra-individual variability in metabolic ratio were made. A positive correlation with body weight suggested dose-dependent metabolism of chlorzoxazone. The intra-individual metabolic ratio in long-term (yearly intervals) and short-term (weekly intervals) variability were similar. The metabolic ratio decreased with increasing chlorzoxazone dose, which supported that metabolism was dose-dependent. CYP2E1 genotypes or ethanol intake the preceding evening did not influence the metabolic ratio. In summary, the metabolism of chlorzoxazone is relatively stable over time, but appears to be dose-dependent at commonly used doses. It is therefore advisable to adjust the dose for body weight.

Study III-V: To study possible sex differences in acute effects and the influence of sex on uptake and metabolism of solvents, women and men were exposed to vapours of *m*-xylene, of 2-propanol and to clean air in an exposure chamber. The volunteers were exposed for two hours at the Swedish occupational exposure limit. Effect measurements included blinking frequency, pulmonary function, nasal swelling, colour vision and inflammatory markers in nasal lavage. In addition, the subjects rated symptoms in a questionnaire. Body fat, weight and height were measured to assess the body build. The solvents and their metabolites were analysed in inhaled air, exhaled air, capillary blood, saliva and urine. The metabolic biotransformation capacity was assessed by phenotyping for CYP2E1 with chlorzoxazone and by genotyping for several metabolic enzymes. The women tended to rate symptoms higher than men. However, there were no significant sex related differences regarding symptom ratings in response to the solvent exposure. Women showed a small but

significant decrease in some pulmonary function parameters after exposure to *m*-xylene. The respiratory uptake was higher and the volume of distribution larger in males. The women had a slightly shorter half time of 2-propanol in blood but approximately four times higher 2-propanol levels in exhaled air at 10 min post-exposure and onwards. The most marked sex difference was that of salivary acetone, where levels increased more than 100-fold in women, but only about 10-fold in men after exposure to 2-propanol compared to clean air.

LIST OF PUBLICATIONS

- I. Ernstgård, L., Gullstrand, E., Johanson, G., Löf, A. Toxicokinetic interactions between orally ingested chlorzoxazone and inhaled acetone or toluene in male volunteers. *Toxicol Sci* 1999;48:189-96
- II. Ernstgård, L., Warholm, M., and Johanson, G. Reliability of CYP2E1 phenotyping by chlorzoxazone *in vivo*. (Submitted)
- III. Ernstgård, L., Sjögren, B., Warholm, M., and Johanson, G. Sex-differences in the toxicokinetics of inhaled solvent vapours in humans. 1; *m*-Xylene. *Toxicol Appl Pharmacol* 2003, in press
- IV. Ernstgård, L., Sjögren, B., Warholm, M., and Johanson, G. Sex-differences in the toxicokinetics of inhaled vapours in humans. 2; 2-Propanol. *Toxicol Appl Pharmacol* 2003, in press
- V. Ernstgård, L., Gullstrand, E., Löf, A., and Johanson, G. Are women more sensitive than men to 2-propanol and *m*-xylene vapours? *Occup Environ Med* 2002;59:759-767

CONTENTS

| | |
|--|-----------|
| INTRODUCTION | 1 |
| ORGANIC SOLVENTS | 1 |
| TOXICOKINETICS OF ORGANIC SOLVENTS | 2 |
| CYTOCHROME P450 2E1 | 4 |
| INFLUENCE OF DRUGS ON ORGANIC SOLVENTS | 5 |
| ACUTE EFFECTS OF ORGANIC SOLVENTS | 6 |
| SEX DIFFERENCES IN ACUTE EFFECTS AND TOXICOKINETICS | 6 |
| THE EXPOSURE CHAMBER | 9 |
| TOXICOKINETIC MODELS FOR ORGANIC SOLVENTS | 10 |
| THE PRESENT THESIS | 12 |
| AIMS OF THE STUDIES | 12 |
| SOLVENTS AND DRUG | 13 |
| METHODS | 15 |
| <i>Exposure conditions</i> | 15 |
| <i>Study groups</i> | 15 |
| <i>Metabolic genotyping and phenotyping</i> | 15 |
| <i>Anthropometrics</i> | 16 |
| <i>Sampling and chemical analyses</i> | 17 |
| <i>Toxicokinetic calculations</i> | 18 |
| <i>Acute effects</i> | 19 |
| <i>Statistical analyses</i> | 20 |
| RESULTS AND DISCUSSION | 22 |
| <i>Interactions between chlorzoxazone and organic solvents (study I)</i> | 22 |
| <i>Reliability of CYP2E1 phenotyping by chlorzoxazone (study II)</i> | 24 |
| <i>Sex differences in toxicokinetics (study III-IV)</i> | 26 |
| <i>Sex differences in acute effects (study V)</i> | 28 |
| GENERAL DISCUSSION | 31 |
| CONCLUSIONS | 33 |
| SAMMANFATTNING (SUMMARY IN SWEDISH) | 34 |
| ACKNOWLEDGEMENTS | 36 |
| REFERENCES | 38 |

LIST OF ABBREVIATIONS

| | |
|-------------------|---|
| 95% CI | 95% confidence interval |
| ADH | alcohol dehydrogenase |
| ANOVA | analysis of variance |
| AUC | area under the (concentration- time) curve |
| BW | body weight |
| CNS | central nervous system |
| CO | carbon monoxide |
| CV | coefficient of variation |
| EH | epoxide hydrolase |
| FEF ₂₅ | forced expiratory flow at 25 % of FVC |
| FEF ₅₀ | forced expiratory flow at 50 % of FVC |
| FEF ₇₅ | forced expiratory flow at 75 % of FVC |
| FEV ₁ | forced expiratory volume in one second |
| FVC | forced vital capacity |
| GC | gas chromatography |
| GST | glutathione transferase |
| hCG | human chorionic gonatropin |
| HPLC | high performance liquid chromatography |
| LBM | lean body mass |
| OEL | occupational exposure limit |
| PCR | polymerase chain reaction |
| PEF | peak expiratory flow |
| ppm | parts per million |
| RFLP | restriction fragment length polymorphism |
| TLco | transfer factor (diffusing capacity for carbon monoxide) |
| TLV | threshold limit value |
| VC | vital capacity |
| ACGIH | American Conference of Governmental Industrial Hygienists |
| IMM | Institute of Environmental Medicine, Karolinska Institutet, Sweden |
| IPCS | International Programme on Chemical Safety, World Health Organisation, Geneva |
| NIWL | Swedish National Institute for Working Life |
| SWEA | Swedish Work Environment Authority |

INTRODUCTION

Exposure to chemical agents is a potential health hazard to hundreds of millions of workers world-wide. Since the 1940s the production of synthetic organic chemicals has risen dramatically, which indicates that there are now many chemicals to which people are likely to be exposed. It is estimated that humans may potentially be exposed to about 60 000 chemicals¹. According to the European Agency for Safety and Health at Work, 22% of employees in European Union member states are exposed to fumes and vapours for at least a quarter of their working time, including organic solvents, wood dust and welding fumes³. Workers can for example be exposed when using chemicals as cleaners, degreasers and thinners. Solvents are also used extensively in the manufacture of different chemicals. The industries using solvents include those related to engineering, printing, painting, construction and repairs¹. Other work situations where workers are exposed to solvents include farming, with potential exposure to pesticides, and office work, with issues such as photocopiers in enclosed spaces.

In the middle of the seventies there was awareness of adverse effects of exposure to organic solvents such as toluene and a substitution and education process started. The workers and the manufactures learnt how to reduce occupational environmental exposure⁴. At printing plants the exposure levels were indeed reduced through better ventilation and more enclosed equipment. For painters, other types of replacement were necessary. Some organic solvents were substituted with water-soluble solvents and manufacturers started painting equipment such as kitchen cupboards before installation. Paints with water-soluble solvents are mostly used for house painting, but for industrial use paints with organic solvents are still the most common⁵. In Sweden it is estimated that 10% of the workforce are exposed to solvents and gases at least a quarter of their working time⁶. The development of the process technique in for example microelectronic industry resulted in a different pattern of exposure to solvents. The workers are now exposed to many different chemicals in low concentrations. However, high, but short-term, exposures can still occur when equipment needs cleaning, service and repair⁷. Today there are thousands of chemicals used as solvents that pose unknown hazards and have unknown effects on the human body. Therefore it is important to study solvents and factors that might influence them.

ORGANIC SOLVENTS

A solvent is a substance that has the ability to dissolve something. Organic solvents are a group with widely differing chemical structure. They are colourless liquids often with a strong smell. The most common characteristic is their ability to dissolve materials not soluble in water, such as fat, rubber and other lipophilic compounds. Organic solvents are used for many purposes: as degreasants, thinners and monomers in polymer production. In many applications for which solvents are used it is their ability to vaporise readily that makes them desirable. This property means that they will be found in the workplace air. Solvents may cause a wide spectrum of health effects. The risks can arise through either direct or indirect contact with the solvent, for example by inhalation of vapours or touching contaminated surfaces.

The toxicity of a chemical is the intrinsic capacity of an agent to adversely affect an organism and can be described by its kinetic and dynamic characteristics. The toxic effect of a solvent can be caused by the chemical itself or by a product formed by biotransformation in the body (metabolite). Knowledge of the biotransformation pathway is essential for understanding what factors are responsible for the effects of a chemical. Toxicokinetics provides information on the concentration of the chemical at the site of action. Toxicodynamics describes the mechanism of action of a compound at the target site.

The toxicity of a chemical cannot be defined without reference to the dose of the substance. Further, the duration of exposure, the type and severity of adverse effects, and the time needed to produce these effects also affect the toxicity. In addition, variations in exposure levels and exposure to mixtures of chemicals make it more difficult to define the exposure and the risk of adverse effects.

When humans are exposed to two or more chemicals or drugs, the substances may interact with each other, thereby altering their toxicity. Substantial interaction can occur in a variety of ways that alter the toxicokinetics of one or both of the interacting toxicants. Two or more substances given simultaneously may produce responses that are independent, additive, synergistic or antagonistic⁸. Antidotes are based on antagonistic effects.

Reasons why certain individuals are more susceptible to toxic effects of solvents than others include genetics, age, disease, body build, and drug interactions. Inherent factors account for the largest part of the variability, although many of the differences among individuals are unpredictable⁹. Analysis of genotypes is a tool to help us predict and understand the variability related to the biotransformation of solvents.

TOXICOKINETICS OF ORGANIC SOLVENTS

Toxicokinetics is the mathematical description of the time course of a chemical in the body. It comprises different processes occurring simultaneously: uptake (absorption), distribution, metabolism (biotransformation) and excretion (figure 1). Disposition refers to the three latter processes.

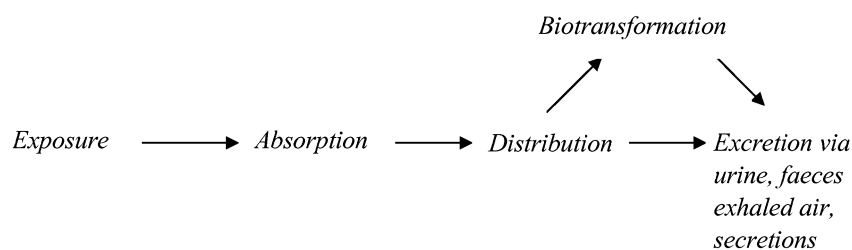

Figure 1. The route of a chemical through the body. Slightly modified from Stacey¹.

Absorption is the process where the chemical enters the body by passing across cell membranes. Solvents are to a large extent highly volatile, so inhalation is normally regarded as the primary route of absorption. For highly water-soluble vapors a major part of the uptake occurs in the nose and the respiratory tree, but for less soluble chemicals it primarily takes place in the lungs¹⁰. In the alveoli the diffusion is so rapid that it does not limit the uptake. The rate of uptake depends on the alveolar ventilation rate, the partitioning between blood and air and the blood perfusion of the lungs¹¹. For solvents that are highly soluble in blood, such as acetone, 2-propanol, toluene and xylene, the uptake is limited by the airflow in the lungs¹².

Through the circulatory system the chemical is distributed to the various body tissues. The distribution depends on blood flow to the tissues, the partitioning between blood and tissue, and elimination rates. Volume of distribution, a term used in toxicokinetics, is the amount of a chemical in the body divided by the concentration in blood, plasma or serum at a given time¹⁰. The value has no physical meaning; it merely indicates where the chemical is distributed. A high value indicates a preference for peripheral tissues and a low value indicates preferential distribution to the blood.

Biotransformation is the process where the chemicals become more polar and less fat-soluble, facilitating excretion from the body. Inhaled chemicals are distributed by the blood circulation to the liver where biotransformation of organic solvents mainly takes place¹⁰. Many organic solvents are to a large extent metabolised by the hepatic enzyme cytochrome P450 2E1 (CYP2E1)¹³⁻¹⁵. This enzyme is further described in section "Cytochrome P450 2E1". The biotransformed product (the metabolite) may be excreted into the urine after being conjugated with water-soluble molecules, such as glucuronic acid, sulphuric acid, and glycine¹⁶.

Excretion is the exit of a chemical and its metabolite from the body. One route of excretion is via the urine. In the kidney, excretion occurs through passive glomerular filtration, passive tubular diffusion, and active tubular secretion. Small, uncharged molecules such as acetone and 2-propanol readily diffuse through the linings in the kidney tubules. The net excretion is therefore driven by a diffusion process determined by the equilibration of partial pressures in blood and urine¹⁷. Volatile chemicals are excreted primarily by the lungs. The process is passive diffusion due to the difference in plasma and alveolar vapour pressure. Volatile chemicals that are highly lipophilic stay longer in the body since it takes some time to migrate from adipose tissue to plasma and further to alveolar space. Less lipophilic volatile chemicals are exhaled fairly promptly, until the plasma level and the ambient air are on the same level.

Elimination of a chemical is the disappearance of a substance from the body. Elimination comprises biotransformation and excretion. To express the rate of disappearance the terms clearance and half-life can be used. The half-life ($T_{1/2}$) is the time needed after end of exposure to reduce the amount in the body to one half. Clearance (Cl) is the volume of blood per time unit that is completely cleared of a substance. The uptake and disposition of a chemical can be described by area under

the curve (AUC). AUC is the integral of concentration in blood over time and is proportional to the absorbed amount of the chemical ¹⁰.

The present thesis deals with some factors which may cause changes in the toxicokinetics of organic solvents. Such changes in the toxicokinetic pattern may alter the relation between external exposure and the target dose and may thus explain some of the observed individual variability in susceptibility to toxic effects. Factors that might influence the toxicokinetics are: the level of physical activity (work load), body composition, age, sex, genotype, ethnicity, smoking, diet and other environmental factors, such as previous or simultaneous exposure to pharmaceuticals and other chemicals ¹².

Physical activity is an important aspect in the toxicokinetics of solvents. Different levels of physical activity required in a workplace lead to a large inter- and intra individual variability. Physical activity increases the pulmonary ventilation and the cardiac output. Alveolar ventilation during exercise can increase as much as tenfold compared to at rest but the cardiac output increases to a lesser extent ¹⁸. This leads to an increase in the solvent uptake ¹⁹. Toluene, acetone and xylene (solvents studied in the present thesis) have all been shown to have an increased respiratory uptake during physical activity ²⁰⁻²².

Toxicokinetics of solvents exhibit considerable inter-individual differences. One cause is variability in metabolic capacity. Polymorphisms have been identified in several enzymes involved in the metabolism of solvents. An influence of the *CYP1A1* genotype on the urinary levels of hippuric acid in Japanese workers exposed to toluene has been described ²³. Polymorphisms that influence the oxidation of ethanol have been detected in *ADH1B* and *ADH1C* ²⁴. A lack of a particular enzyme or conversely, having an enzyme with high activity may lead to an adverse reaction.

Further, biotransformation can be induced or inhibited, and thus the metabolic capacity may be influenced by illness, aging, dietary habits and exposure to xenobiotics ²⁵. Pharmaceutical drugs, alcohol intake, tobacco smoke, and other environmental pollutants are common sources of xenobiotics. As exposure to solvents is common in workers worldwide, it is important to study their toxicokinetics and factors that might interact with their biotransformation.

CYTOCHROME P450 2E1

Phase I metabolism, in which the P450 system is the major part, is thought to be the rate limiting step in many metabolic processes. CYP2E1 is an important metabolic enzyme that catalyses the biotransformation of numerous industrial chemicals in the low molecular weight range (toluene, xylene, styrene etc) ^{26,27}. CYP2E1 is found principally in the liver, but also in several extrahepatic tissues (kidney, lung etc). For maximal rates of metabolism the presence of NADPH, NADPH-cytochrome *P*-450 reductase, and lipids are required. CYP2E1 reduces O₂ to superoxide anion and H₂O₂ in the absence of substrates for hydroxylation and even in their presence, since CYP2E1 is a “leaky” enzyme. CYP2E1 is an inducible enzyme and CYP2E1 induction is associated with increased release of toxic oxygen free radicals. Further, CYP2E1

activates a score of xenobiotics to highly hepatotoxic compounds. The regulation of CYP2E1 expression is complex ²⁸.

Considerable inter-individual variability in human CYP2E1 activity has been observed both *in vitro* using liver microsomes ²⁹⁻³⁰, and, to a somewhat lesser extent, *in vivo* based on the 6-hydroxylation of chlorzoxazone as a probe (further described in the section “Metabolic genotyping and phenotyping”) ³¹⁻³². Genetic variability has been seen in the gene coding for CYP2E1 ^{28,33-34}. Recently it has been concluded that the variability is mainly related to polymorphic sites in the promoter region ³⁵. For example, in a study among individuals who either were obese or had recently consumed ethanol, the allele *CYP2E1*1D* was shown to be associated with a greater CYP2E1 metabolic activity ³⁶. The rare *CYP2E1*1B* allele was recently shown to be associated with increased metabolism of styrene in a study on workers from a plastics factory ³⁷. In a study by Iwahashi and colleagues ³⁸ there was an indication of an effect of the *CYP2E1* genotype on metabolism of ethanol, in that individuals with the c1/c2 genotype had a slower elimination of ethanol from blood compared to subjects with the c1/c1 *CYP2E1* genotype. Isothiocyanates, to which humans are exposed via the food, can inhibit CYP2E1 ³⁹.

CYP2E1 has both toxicological and physiological roles as it catalyses the oxidation of a large number of exogenous and endogenous substrates. Endogenous regulation of CYP2E1 is affected by different physiological conditions such as fasting ⁴⁰, obesity ⁴⁰, and liver dysfunction ⁴¹. Exogenous factors include induction by ethanol ³² and inhibition by drugs ⁴². These factors have been shown to influence CYP2E1 activity and to contribute to the inter-individual differences.

INFLUENCE OF DRUGS ON ORGANIC SOLVENTS

Drugs may influence the toxicokinetics of solvents by inhibiting or stimulating their metabolism or changing the pulmonary as well as the peripheral blood flow. The main interaction effect of drugs is probably interference with the biotransformation of solvents. Many solvents are to a large extent metabolised by the same enzyme, CYP2E1 ¹³⁻¹⁴ that also metabolises pharmaceutical drugs such as acetaminophen (paracetamol) and chlorzoxazone (Paraflex ®). Chlorzoxazone is metabolised by CYP2E1 to a single oxidised metabolite, 6-hydroxychlorzoxazon ⁴³. It has been shown that a number of chemicals compete with the 6-hydroxylation of chlorzoxazone in human liver microsomes ⁴⁴. Hence, one may speculate that co-exposure to solvents and chlorzoxazone at sufficiently high doses may result in delayed metabolism and changes in the toxicokinetic patterns of one or both substrates.

It has been shown that intake of paracetamol (acetaminophen) increased the concentration of toluene in the blood of volunteers exposed to toluene vapour ⁴⁵. Further, Campbell et al ⁴⁶ showed that acetylsalicylic acid decreased the transformation of *m*-xylene to methyl hippuric acid. However, little information is available to predict effects of potential interactions of most hazardous chemicals and drugs.

ACUTE EFFECTS OF ORGANIC SOLVENTS

Solvents may cause a wide spectrum of health effects. In Sweden in 1999 about 200 cases of solvent-related injury were reported⁵. About 30% of the reported cases were related to irritation in the respiratory system, including asthma. Nine of the cases were chronic toxic encephalopathy, also called psychoorganic syndrome. Most of the organic solvents are depressants of the central nervous system (CNS). In the lipid layer of the cell membranes solvents may interfere with nerve cell function, thereby resulting in a variety of effects. Acute exposure can cause headache, dizziness, nausea and confusion. Coma and failure of the vital brain centre, sometimes with fatal results, may be caused by severe exposure. Chronic exposure may lead to for example headache, disturbed sleep, impaired colour vision and poor memory¹. Most of the acute effects of solvent exposure are reversible, since they are caused by functional changes and not morphological damage.

One risk that is run by workers exposed to solvents is developing deficits in colour vision. During the two last decades there have been many investigations on the potency of industrial chemicals to impair colour vision. The studies have shown an impairment of colour vision after chronic exposure to mixtures of solvents⁴⁷⁻⁵⁰ and to styrene⁵¹⁻⁵⁴. That toluene exposure at workplaces has an effect on colour vision has not been established, since only minor effects and some negative investigations have been reported. However, acute exposure (6 h) to 100 ppm toluene caused decreased colour discrimination⁵⁵. Studies on the neurological effects of 2-propanol are rare. However, in an investigation by Sethre and colleagues⁵⁶ it was found that 2-propanol, like other alcohols, affected postural balance.

Irritation of the eyes and mucous membranes is the most common critical effect of workplace chemicals. Toluene and acetone are two substances that have a mild to moderate irritative effect on the mucous membrane. After accidental industrial poisoning, a third of the workers exposed to toluene or xylene complained of cough, and shortness of breath⁵⁷. Sensitive subjects with bronchial hyperreactivity may be affected by exposure to solvents at lower levels⁵⁸.

Many functions in the body such as blood pressure, sleep-wake cycle, renal function and urine volume, change regularly over time⁹. These time-dependent variations could be involved in the disposition of chemicals. The period of a cycle is often diurnal (approximately 24 h) but can be longer or shorter. An example of a cycle in the body with a longer period is the menstrual cycle. The pulmonary function is an example that has a diurnal variation. Humans perform the best pulmonary function test at noon⁵⁹. The concentration of hormones is time-dependent and changes in sex hormones can be diurnal (as testosterone) or diurnal superimposed on the changes that occur during the menstrual cycle (as prolactin).

SEX DIFFERENCES IN ACUTE EFFECTS AND TOXICOKINETICS

Women in Sweden and other European countries have started to work in industrial settings to a larger extent in recent years. Occupational exposure of women to organic solvents may thus be more common than previously. Roughly 10% of the Swedish

workforce is exposed to solvents, and almost half of them are females⁶. In spite of this, studies on the health effects of solvents have almost entirely been carried out in men⁶⁰. Thus, risk assessment and risk management, including occupational exposure limits, are based on findings in men. Women are therefore at risk of not being adequately protected, should they be more sensitive than men to chemical exposures. The influence of sex on toxicokinetics may involve female-male differences in physical constitution, physiology, and metabolising enzymes (Figure 2). Women and men differ in average body composition, which may cause significant sex differences in toxicokinetics.

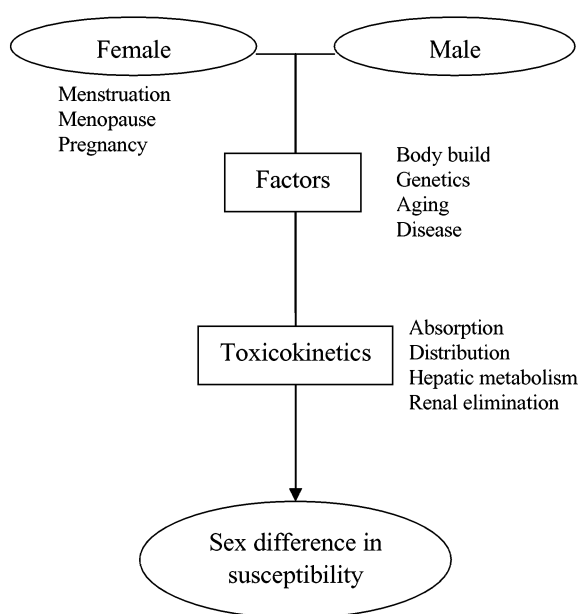

Figure 2. Possible mechanisms of sex differences on solvent metabolism. Slightly modified from Tanaka et al.².

In general, men have more muscle mass and a greater body weight and women have a higher percentage of fat tissue. These differences are expected to influence the apparent distribution of xenobiotics, especially lipophilic ones, as well as the extent and rate of accumulation and release from adipose tissues⁶¹. Thus, women might well reach higher exposure doses of organic solvents and be exposed for longer periods of time than men. It has been reported that women appear to eliminate benzene at a slower rate compared to men and that this difference is mainly due to the larger amount of body fat in women⁶². The difference in body size also results in a faster total clearance of most drugs in men compared to women⁶³. The glomerular filtration is proportional to weight and weight is generally higher in males than in females. Schwartz and colleagues⁶⁴ concluded that adjustment for body weight only would not avoid all sex-related differences in toxicity, so other factors must also be considered.

Sex differences in metabolising enzymes have been proposed. CYP2E1 activity has been assessed by using chlorzoxazone metabolism (in detail in the section “Metabolic genotyping and phenotyping”) and a higher clearance in healthy men (about 30% higher) compared to healthy women has been found in several studies^{2, 31, 65}. A greater clearance in men compared to women has also been found when CYP1A2 phenotype was determined by caffeine administration⁶⁶⁻⁶⁸. However, this sex difference was eliminated when hormone replacement therapy or oral contraceptives were administered⁶⁴. In contrast to CYP2E1 and CYP1A2, the activity of CYP3A4, the enzyme involved in the metabolism of the largest number of medications, appears to be higher in females, as faster clearance of several substrates has been reported in women compared to men^{30, 69-71}.

Sex hormones, the phase of the menstrual cycle, and oral contraceptive steroid administration can cause sex differences in drug disposition⁶¹. Paracetamol clearance was 22% higher in males compared to females not taking oral contraceptives after a single-dose administration in 24 healthy volunteers. However, females taking oral contraceptives demonstrated a 49% higher clearance than females without oral contraceptives⁷². Investigations on the influence of the menstrual cycle and sex hormones on the metabolism of drugs have been done and, for example, the half-life of antipyrine in plasma was in some cases reduced by 50% around the time of ovulation⁷³. Estrogen has been proposed to inhibit and progestogens may induce the phase II metabolism of drugs⁷⁴. Such sex differences may also influence the toxicokinetics of solvents.

Sex differences in ethanol kinetics have been extensively studied⁷⁵⁻⁷⁶. It is well known that women reach higher blood levels of ethanol compared to men after oral intake of equal amounts, expressed per kg body weight, of alcohol⁷⁷. The difference is partly explained by body build, as the difference between sexes is much smaller when the dose is corrected for lean body mass. The remaining difference has been attributed to a smaller gastric metabolism of ethanol in women⁷⁵.

Sex differences in pulmonary function have been reported. Males tended to perform better than females with the same anthropometrics. The airways in women (20 to 36 yr of age) had about 20% smaller diameters than the airways of men (23 to 48 yr of age). However, for approximately the same lung size, there was no indication that the pulmonary function in males would exceed that of females⁷⁸.

There is also a sex difference in reporting symptoms. Women have consistently been shown to report more physical symptoms in general. Kroenke and colleagues⁷⁹ showed that women reported significantly more symptoms in 10 out of 13 questions. This is also supported by Tibblin and colleagues⁸⁰ who investigated the occurrence of 30 symptoms by age and sex in two populations and found that women in general rated symptoms like dizziness, headache, general fatigue, and nausea higher. These authors suggested that women and men have different life-styles, and that women’s higher degree of symptoms may be due to more responsibilities and higher workload (job, home, and bringing up the children). However, Pennebaker⁸¹ noticed a sex difference in how individuals notice, define, and react to symptoms. Women were particularly

sensitive to external environmental signs in defining their symptoms while men were more attentive to bodily changes.

EXPOSURE CHAMBER

In our 20-m³ in-house exposure chamber made of stainless steel (Figure 3) it is possible to expose humans to solvents. The exposures are carried out under well-controlled conditions, with respect to solvent exposure level and duration as well as to temperature and humidity. A high-performance liquid chromatography pump transfers the solvent to a preheated glass tube, where the solvent is vaporised. The completely vaporised solvent follows the influent air stream into the exposure chamber. The concentration of solvent in chamber air is analysed during exposure by a gas chromatograph. The volunteers in the studies in the present thesis were exposed primary by inhalation.

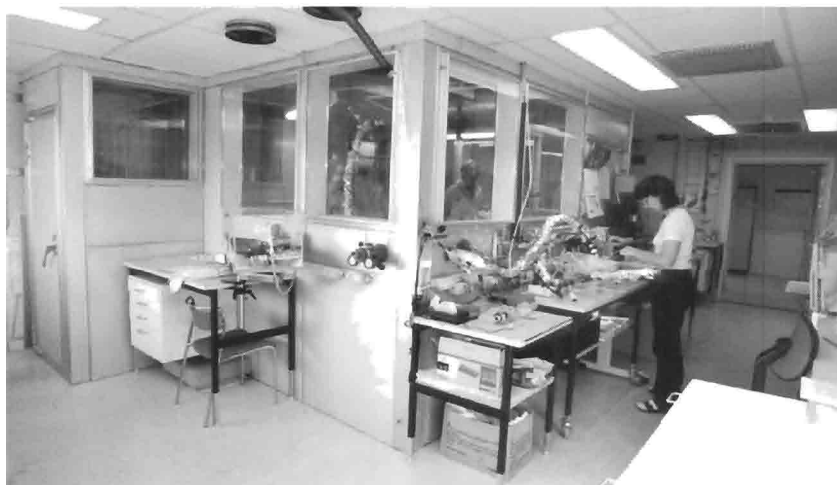

Figure 3. Exposure chamber.

It is also possible to expose humans solely through the skin, by using a fresh air face mask during exposure which was done in a study on vapours of 2-butoxyethanol⁸². To prevent leakage of solvent, the air pressure in the chamber is kept lower than in the surrounding laboratory. In the chamber the subjects may perform exercise at different workloads on a bicycle ergometer or be seated at rest. The exposures in the toxicokinetic studies in the present thesis were performed at a physical workload of 50 W on the bicycle ergometer. This light exercise imitates the conditions in light industry work. During exposure it is possible for the volunteers to leave samples of exhaled air by breathing in a mouthpiece at selected time intervals. The pulmonary ventilation and breathing frequency are measured with a spirometer. It is also possible to take capillary blood samples through a closable hole in the chamber wall. During chamber exposure, physical data, including pedalling frequency, actual workload, and heart rate, are continuously recorded at 1 min intervals on a personal computer. The heart rate is recorded by means of automatic electrocardiographic telemetry.

A strength of chamber exposure studies is that the subjects serve as their own controls, excluding spurious effects due to individual differences in physiological parameters. The possibility to take blood and exhaled air samples during exposure makes the exposure chamber excellent for studies on toxicokinetics. Further, for studies of acute effects the exposure chamber is also a useful tool. A disadvantage of chamber exposure studies is that they limit the number of subjects: the space needed for bicycle ergometers, air changes per hour and places for sampling blood and exhaled air reduce the number of subjects.

The exposure chamber has previously been used in many toxicokinetic studies, for example in studies on terpenes, ethers and trimethylbenzenes^{83, 84-88}. Further, acute effects of ethers have also been studied in the exposure chamber⁸⁹⁻⁹⁰.

TOXICOKINETIC MODELS FOR ORGANIC SOLVENTS

To understand and describe the uptake and disposition of solvent vapours in humans, mathematical models may be used. In the model the organism is represented by one or more compartments (Figure 4A-C). The compartment is a theoretical volume in which the chemical is assumed to distribute homogeneously and instantaneously. The models can be divided in two categories: descriptive and physiological. In the descriptive model, the collected data are fitted to the model by changing the values of the parameters, and in more complicated models also by changing the structure of the model. Advanced descriptive models allow for “goodness of fit” statistical comparison of toxicokinetic parameters and can identify contribution of covariates on toxicokinetics. Further advantages of descriptive models are that there is no need for additional data and that few assumptions are made. A weakness is that the output parameters have no direct correspondence to the actual physiology and that they are of limited usefulness for other chemicals, for other exposure routes, and other species¹⁰.

Physiological models (Figure 4D) describe the body as a set of tissue compartments connected by the blood flow. Differential equations based on mass balance are used in the model. After building the model, necessary data are collected, predictions are made and the model is then refined by comparison with experimental data. An advantage of the physiological model is that it can be used for extrapolations as for example to study the influence of physical activity on uptake and disposition of inhaled organic solvents¹⁰. A weakness of physiological models is that they are time- and data-intensive relative to descriptive models.

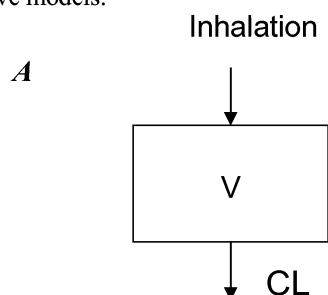

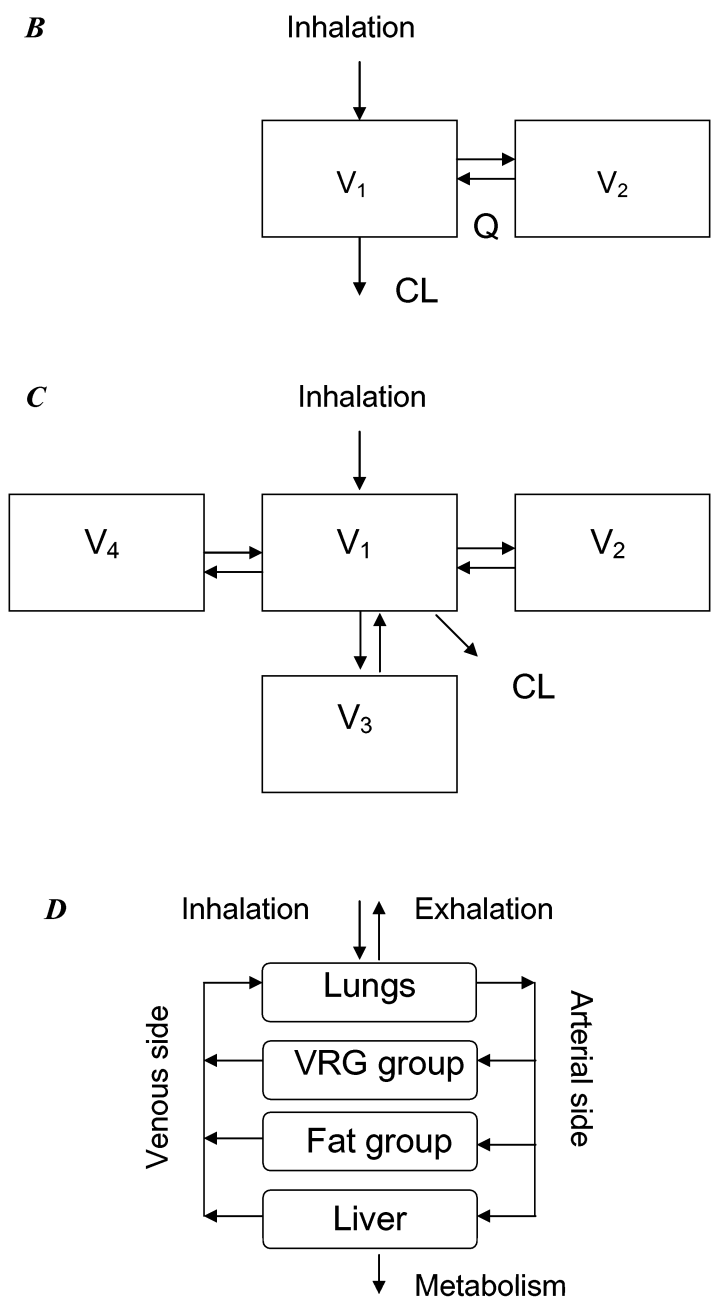

Figure 4. A: structure of a 1-compartment model, used for acetone and 2-propanol (study I, IV).

B: structure of a 2-compartment model, used for *m*-xylene (study III).

C: structure of a 4-compartment mamillary model, used for toluene (study I).

D: structure of a PBPK model, not used in this studies.

THE PRESENT THESIS

AIMS OF THE STUDIES

The main purpose of this thesis, with emphasis on human experimental data, was to study influence of sex, CYP2E1 and a pharmaceutical drug on uptake and metabolism of organic solvents. More specifically the aims of the studies were to investigate:

- influence of chlorzoxazone on uptake and metabolism of solvent vapours
- the reliability of CYP2E1 phenotyping *in vivo* using chlorzoxazone
- influence of sex on uptake and metabolism of solvent vapours
- influence of sex on acute effect of solvent vapours

SOLVENTS AND DRUG

The solvents used in the present thesis were selected as model substances. In study I, III and IV they were selected so as to have different lipophilicity and in study I they were also to be at least partly metabolised by CYP2E1. All solvents were to be in common use and without known serious health effects at low or moderate exposures. All exposures were carried out at the current Swedish occupational exposure limit (8-h time-weighted average). The occupational exposure level is set to prevent adverse effects in nearly all workers with daily exposure. The legally binding occupational exposure level in Sweden is an administrative value where also social and economical factors and technical feasibility are taken into account.

| | <i>Occupational exposure limit</i> |
|-------------------|---------------------------------------|
| <i>Acetone</i> | <i>600 mg/m³ (250 ppm)</i> |
| <i>Toluene</i> | <i>200 mg/m³ (50 ppm)</i> |
| <i>m-Xylene</i> | <i>200 mg/m³ (50 ppm)</i> |
| <i>2-Propanol</i> | <i>350 mg/m³ (150 ppm)</i> |

Table 1. The Swedish occupational exposure limit (8-h time-weighted average) for the solvents used for exposure in the studies⁹¹.

Acetone (study I) is a polar solvent used in the lacquer, varnish, rubber, plastics and chemical industries. In humans, low concentrations of acetone are present in biological fluids and derive from the metabolism of fat and carbohydrates. The respiratory uptake of acetone is about 45% both at rest and during light physical exercise. Of the absorbed dose of acetone, 20% is eliminated via the lung and 1% unchanged in the urine. Acetone may also be further metabolised to acetate, formate and finally carbon dioxide⁹². Over 75% of the acetone absorbed in humans is excreted as metabolites in the urine²¹. Occupational exposure to acetone leads to: irritation of the mucous membranes and effects on the central nervous system.



Acetone

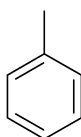

Toluene

Toluene (study I) is a non-polar solvent used in the rubber, plastics, leather, paint, printing, and chemical industries. The first step in the metabolism of toluene is the formation of benzyl alcohol by CYP2E1, followed by oxidation to benzaldehyde and benzoic acid catalysed by alcohol dehydrogenases and aldehyde dehydrogenases, respectively. Benzoic acid is to a large extent conjugated with glycine and excreted as hippuric acid in the urine. Benzoic acid may also be conjugated with glucuronic acid and excreted as benzoyl glucuronic acid. However, approximately 75% of the toluene

absorbed is excreted as hippuric acid. Exposure to toluene affects primarily the central nervous system but may also cause mild throat and eye irritation ⁹³.

m-Xylene (study III, V) is a non-polar solvent used in paints and in the production of phthalic anhydride, plasticisers, and polyesters. The major metabolic route of *m*-xylene in humans is side-chain oxidation to *m*-methyl benzaldehyde and *m*-methyl benzoic acid and further conjugation with glycine to form *m*-methyl hippuric acid ⁹⁴.

Depression of the central nervous system, and irritation of the upper respiratory system and the eyes are the most common effects of occupational exposure to xylene ⁹⁴. The level at which *m*-xylene has no observable adverse effects on CNS in humans is about 70 ppm (280 mg/m³) for a 4-h exposure ⁹⁴.

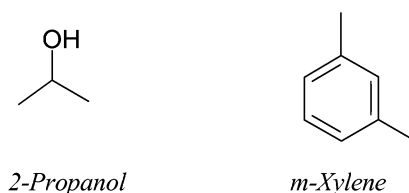

2-Propanol (study IV, V) is a polar solvent that is widely used both in industry and in consumer products. It is used as a disinfectant in homes, hospitals and industries, as a solvent in the production of hair and skin products, as an anti-freezing agent in fuel-systems, in windshield-washers, in lens cleaners, and in racing motor fuels. The major metabolic pathway of 2-propanol is oxidation by liver alcohol dehydrogenase and by CYP2E1 to acetone. Acetone is then eliminated and may be further metabolised as described in the part about acetone (above). Irritation of the respiratory system, eye and mucous membranes is the critical effect of 2-propanol. Central nervous system effects such as dizziness, nausea, hypotension, and hypothermia are caused by higher concentrations of 2-propanol. The TLV is set on the basis of eye, nose and throat irritation and 2-propanol is of low toxicity by any route.

The pharmaceutical drug used in the present thesis (study I - IV) is Paraflex © (chlorzoxazone, 5-chlorobenzoxazol-2(3H)-one). It was selected as it is metabolised by CYP2E1. Paraflex © is used for relief of painful musculoskeletal conditions. It is well tolerated and seldom produces undesirable side effects. Chlorzoxazone is metabolised by CYP2E1 to a single oxidised metabolite, 6-hydroxychlorzoxazone (Fig 5).

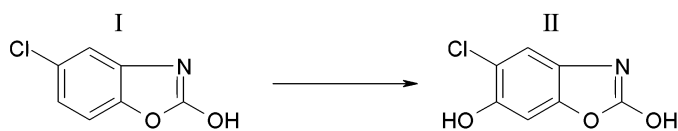

Figure 5. Chlorzoxazone (I) and 6-hydroxychlorzoxazone (II)

METHODS

The analysis methods are described in detail in the original papers.

Exposure conditions

In study I healthy volunteers were exposed by inhalation to vapours of acetone (250 ppm) and toluene (50 ppm); in study III, IV and V to vapours of 2-propanol (150 ppm) and *m*-xylene (50 ppm). The exposures were carried out in our exposure chamber (previously described in section "Exposure chamber") for 2 h. The chamber climate was maintained at an air temperature of 18-20 °C and a relative humidity of 30-40%. In study I, III-V the subjects were informed about the experimental design but unaware of the exposure sequence.

Study groups

Ten healthy male Caucasian volunteers, age 24–49, participated in study I. They were recruited by advertising.

Study II started with 27 healthy male Caucasian volunteers, age 26-53 and 9 females age 27-48. Twenty of the volunteers were recruited by advertising; 9 females and 7 males were from studies III and IV.

Nine females, age 27-48 and eight males, age 26-49, participated in studies III and IV. The volunteers were recruited among the participants in study V.

Fifty-six Caucasian volunteers (28 men and 28 women), age 20-49, participated in study V. The volunteers were recruited from a randomly selected subgroup of 2000 persons between 20 and 50 years of age in the Stockholm population registry.

The studies were carried out after the volunteers had been through a medical examination that included a health questionnaire, a general physical examination, and standard clinical blood and urine analyses. The females in study III and IV were not taking oral contraceptives. All females performed a negative pregnancy test immediately before each exposure. All participants were non-smokers (except in study II) and had no history of allergies or chronic diseases. The volunteers were included in a study only if considered healthy. The subjects stated no previous occupational exposure to any organic solvent. The participants had to refrain from alcoholic beverages and drugs at least 48 h before and throughout the experiment. The volunteers were informed orally and in writing about the design of the study, possible hazards, and their freedom to discontinue whenever they wanted. The studies were performed after approval from the regional ethics committee at Karolinska Institutet, Stockholm.

Metabolic genotyping and phenotyping

Genotyping, study I- IV

DNA was prepared from white blood cells. After lysis and proteinase digestion the samples were subjected to a modified salting out procedure⁹⁵. DNA was isolated after precipitation with ethanol.

The *RsaI* polymorphism in the 5'-flanking region of CYP2E1 was analysed by polymerase chain reaction/restriction fragment length polymorphism (PCR/RFLP) as described in ⁹⁶ (study I-IV). The insertion (96 bp) polymorphism in a repeat region of the promoter was determined by PCR, using 5' TGG TAC ATT GTG AGA CAG TG 3' as the forward primer and 5' ATA CGG GAA CAC CTC GTT TG 3' as the reverse primer ⁹⁷ yielding fragments of 633 bp (6 repeats; *CYP2E1*1C*) and 729 bp (8 repeats; *CYP2E1*1D*) ⁹⁸ (study II). The G₋₃₅T (5'-flanking region) polymorphism was determined by PCR/RFLP as described by Fairbrother and coworkers ⁹⁹ (study II). The *TaqI* polymorphism in *CYP2E1*1B* was determined by PCR/RFLP as described by Haufroid and colleagues ³⁷ (study II).

PCR analyses of two closely linked polymorphisms in *CYP1A1*, that create an *MspI* restriction site and a substitution in exon 7 resulting in an amino acid change, were performed as described in ¹⁰⁰ (study II-III).

The genetic polymorphism in exon 8 of alcohol dehydrogenase 1C was determined by PCR/RFLP using *SspI* ¹⁰¹ (study IV). Glutathione transferase M1 null (-) individuals were identified by PCR essentially according to Brockmöller and coworkers ¹⁰² (study II-III). Analyses of the GSTP1 polymorphisms that result in an Ile to Val substitution at amino acid residue 104 and an Ala to Val substitution at residue 113 were performed as previously described ¹⁰⁰ (study III). The polymorphism in exon 3 of microsomal epoxide hydrolase was analysed by allele-specific PCR as previously described ¹⁰⁰ (study III). Genotyping of three functional polymorphisms (341 T >C, 590 G >A, 857 G >A) in N-acetyltransferase 2 (NAT2) was performed as described in ¹⁰³ (study II).

Phenotyping, study II, III and IV

The CYP2E1 phenotype was determined *in vivo* using the 6-hydroxychlorzoxazone/chlorzoxazone plasma concentration ratio (metabolic ratio) at 2 h after oral intake of 500 mg of chlorzoxazone (study III-IV). In study II the metabolic ratios were determined at 2, 4 and 6 h following an oral dose of 500 mg chlorzoxazone. In addition, the metabolic ratios at a higher (750 mg) and a lower (250 mg) dose were measured. Analyses of chlorzoxazone and its 6-hydroxy metabolite in plasma were performed by HPLC as further described in the studies.

The NAT2 phenotype was deduced from the genotype and subjects were classified as slow (carriers of two mutations), intermediate (carriers of one mutation) or rapid (carriers of wild type alleles only) acetylators (study II).

Anthropometrics

The amount of body fat of the subjects was estimated by bioelectrical impedance (Figure 6) (study III-IV). Weight (bw) was measured on a scale to the closest 0.5 kg. Height (ht) was measured to the closest cm. Body mass index was calculated as bw/ht². In study II lean body mass (LBM) and total body fat was calculated from body weight and height according to equations given by Droz et al ¹⁰⁴.



Figure 6. Body fat measurements by bioelectrical impedance: electrode placement and subject positioning

Sampling and chemical analyses

Exhaled air

To determine the respiratory excretion of solvents (acetone, toluene, 2-propanol, and *m*-xylene) mixed exhaled air was collected (figure 7). The procedure is described in detail in ⁸⁷. To achieve higher analytical sensitivity, samples of exhaled air after the exposure was adsorbed on stainless steel adsorption tubes. About 10 L of mixed exhaled air was collected during 1 min by means of an air pump. Samples were desorbed and analysed using Automated Thermal Desorption.



Figure 7. Collection of mixed exhaled air.

Capillary blood

Capillary blood was sampled for analysis of solvents (acetone, toluene, 2-propanol, and *m*-xylene) during and after exposure at scheduled time points. Prior to capillary blood sampling, the volunteer immersed the hand in warm water for 1 min. Blood was collected in heparinised glass capillaries and immediately transferred to a 20-ml

glass headspace vial. The vial was immediately sealed with a Teflon-lined rubber septum and analysed by headspace GC.

Saliva

In study III-IV saliva samples were collected. For collection of saliva two cigarette filters (diameter 8 mm, length 20 mm) were kept for 1 min in the lower cheek outside the teeth. The filters were then transferred to a 20-ml glass headspace vial. The saliva samples were analysed by headspace GC.

Urine

All urine was collected until 24 h post exposure in study I, III and IV. The volunteers were instructed to completely void the bladder on each occasion. Urine was collected in 500-ml glass bottles, which were immediately capped with polyethylene screw caps. Samples were processed within 5 min and analysed by headspace GC. In addition, an aliquot was stored at -20°C until analysis of the metabolites.

In study II, urine samples were collected at the same times as the venous blood samples and also at 8 h after the intake of chlorzoxazone. The total volume was recorded for each sample and an aliquot was stored at -20°C until analysis of 6-hydroxychlorzoxazone.

Venous blood

Venous blood was collected from the brachial vein in heparinised tubes at indicated time points after the administration of chlorzoxazone (study II). Pre-exposure venous blood samples were also used to confirm the absence of solvents (toluene, 2-propanol and *m*-xylene), to obtain pre-exposure values of acetone and to prepare analytical calibration standards (study I-IV). Prior to exposure, venous blood was also drawn to a tube containing sodium citrate, for preparation of DNA and subsequent genotyping.

Toxicokinetic calculations

Respiratory net uptake was calculated as the difference between the amount solvent in inhaled and exhaled air, during exposure (study I, III and IV). Individual kinetic calculations were performed on data from all exposures. For calculation of toxicokinetic parameters in study I the blood-concentration-time data were fitted to a linear one compartment (acetone) (Figure 4A), or a four compartment (toluene) (Figure 4C) model written in Microsoft Excel v.4.0 (Johanson, unpublished). The experimental data were fitted to the model by minimising the residual sum of squares using Excel Solver.

The time course of *m*-xylene and 2-propanol in blood (study III, IV) was analysed by mixed effects modeling using the NONMEM software (version V, San Francisco, USA) ¹⁰⁵. A one-compartment model was used for 2-propanol in blood (Figure 4A) and a two-compartment model was used for *m*-xylene in blood (Figure 4B). Graphic analyses of predictions and residuals were performed using the software Xpose 2.0 ¹⁰⁶. The influence of covariates was investigated by adding them one at a time and testing whether this addition resulted in a statistically significant improvement of the description of the data by the model.

In calculations, a value corresponding to half of the detection limit was used for samples below the detection limits. The area under the curve (AUC) of urine, saliva and exhaled air was calculated by the trapezoidal rule (study I, III and IV).

Acute effects

In study I acute effects were measured subjectively by ratings of symptoms. Further, sex differences in acute effects were measured, objectively and subjectively, in study V. A control condition (clean air) was included, so that the subjects could serve as their own controls.

Ratings of symptoms

The subjects rated the level of perceived discomfort in a questionnaire. There were ten questions, in Swedish, related to irritative symptoms (eyes, nose, throat or airways), the central nervous system (headache, fatigue, feeling of sickness, dizziness, intoxication), difficulty in breathing, and smell of solvent. The ratings were performed using a 100-mm visual analogue scale (Figure 8)¹⁰⁷. The questionnaire was elaborated for vapour exposure and has been used in several inhalation studies, for example in^{83-84, 89, 108}.

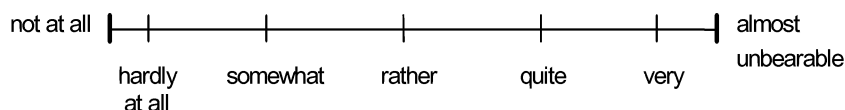

Figure 8. Visual analogue scale (VAS) for the ratings of symptoms.

Pulmonary measurements

Spirometry. Pulmonary function measurements were performed using a calibrated spirometer (Vitalograf) along with computer software (Spirotrac 3). The subjects wore a nose clip and were asked to inhale as much as possible and thereafter exhale completely in a mouthpiece. Measurements included vital capacity (VC), forced vital capacity (FVC), forced expiratory volume in 1 second (FEV₁), peak expiratory flow (PEF) and forced expiratory flow in 25%, 50% and 75% of FVC (FEF₂₅, FEF₅₀, FEF₇₅). Secondary parameters calculated from the spirogram were FEV₁/FVC and FEV₁/VC.

Diffusion capacity. Measurements of diffusing capacity for carbon monoxide in the lung (DL_{CO}) were performed according to the single breath holding method¹⁰⁹⁻¹¹⁰. In brief, the subject inhaled a maximal breath of a test gas containing carbon monoxide (0.3%) and helium (14%), held it in the lungs for 8 seconds, and exhaled. A sample of the exhaled alveolar gas was taken for analysis.

Nasal measurements

Acoustic rhinometry. Nasal swelling was assessed by acoustic rhinometry. This method describes the geometry of the nasal cavity by analysing the reflections of an

acoustic signal. The nasal volume and the minimal nasal cross-sectional area were determined as an average of three measurements in each nostril.

Nasal lavage. Inflammatory markers were measured in nasal lavages as previously described by Nihlen and colleagues⁹⁰. In brief, each side of the nasal cavity was rinsed with 5 ml of sterile physiological saline. The analyses of inflammatory markers included myeloperoxidase, eosinophilic cationic protein, lysozyme, and albumin.

Ocular measurements

Blinking frequency. Eye blinking was monitored by electromyography (EMG). Three EMG electrodes were affixed around the left eye (Figure 9). The EMG signal was amplified and transferred via telemetry to a personal computer¹¹¹. A software program in C++ was used for identification of the characteristic EMG signal pattern. Identification of eye blinks was performed by comparison against nine conditions related to the size, shape and appearance of the pattern. Results were presented as blinks per minute in 20-min intervals during the exposure.



Figure 9.

Colour vision

Colour vision was assessed with the Lanthony D-15 desaturated panel colour arrangement test¹¹². The subjects used both eyes when performing the test and those who normally used glasses wore them also during the test. Quantitative evaluation was made by calculating the colour confusion index (CCI)¹¹³.

Statistical analyses

The Shapiro-Wilk test was used to test for normality (JMP v. 3.02, SAS Institute Inc) in study II – V. In study III and IV most observations were log normally distributed; therefore statistical calculations (means, confidence intervals, t-test etc) were made on log transformed data.

Statistical comparisons of the different exposure conditions and between sexes were made using the two-tailed, paired Student's t-test (study I-IV).

To evaluate the symptom ratings, in study I repeated measures analysis of variances in the SuperANOVA 1.11 (Abacus Concepts, Inc., Berkeley, Ca) was performed. The repeated measures analysis of variance (ANOVA) in the StatView software v.5, SAS Institute Inc) was used to calculate the results of blood/air coefficients (study IV) and to compare the three dose levels and variation over time in study II.

In study V, the Wilcoxon signed rank test and the Mann-Whitney U-test in the StatView (v.5, SAS Institute Inc) were used to test for differences in symptom ratings between exposure conditions and sexes, respectively.

For correlation analysis linear regression in StatView (v.5, SAS Institute Inc) or JMP (study II) was used.

ANOVA in StatView was used to determine associations between metabolic ratios, genotypes and phenotypes. Wilcoxon test in JMP was used to determine associations between urinary recovery of chlorzoxazone, genotypes and phenotypes.

In all statistical analyses the significance level was set at 0.05.

RESULTS AND DISCUSSION

Interactions between chlorzoxazone and organic solvents (study I)

Study design

Ten male volunteers were exposed to solvent vapour for 2 h at a workload of 50 W. Each subject was exposed to acetone only (250 ppm), acetone+ chlorzoxazone, toluene only (50 ppm), toluene + chlorzoxazone, and chlorzoxazone only. Chlorzoxazone (500 mg, corresponding to 2.9 mmol) was taken as two tablets 1 h prior to solvent exposure.

Results

Acetone in blood continued to increase during the 2-h exposure period with almost no tendency to level off (Figure 10). Acetone in blood appeared to follow a mono exponential decay curve after exposure. The background level of acetone in blood was 47.3 $\mu\text{mol/L}$ (C.I. 40.4–54.2 $\mu\text{mol/L}$).

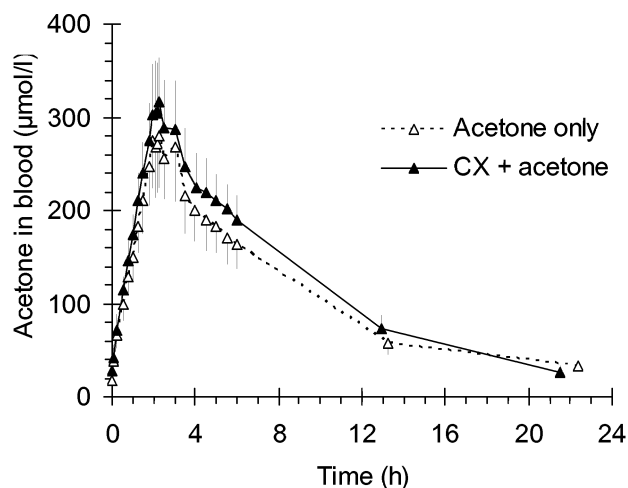

Figure 10. Average concentration of acetone in blood with and without oral intake of chlorzoxazone 1 h before start of 2 h exposure of acetone (250 ppm). Vertical lines indicate 95 % CI.

With regard to relative net uptake, absolute net uptake and exhaled concentration of acetone, no differences between exposure conditions (acetone only and acetone + chlorzoxazone) could be demonstrated. In contrast, a statistically significant increase of acetone in blood (Figure 10) and urine was seen after chlorzoxazone intake. A significant, 25% increase in AUC, from 2.02 to 2.53 $\text{mmol/L}\cdot\text{h}$ was suggested by the least-square best fit of the concentration-time curve to a one compartment model. A tendency towards slightly prolonged half times was seen. However, the post-exposure decay curve of acetone in blood was seemingly less affected. After intake of chlorzoxazone the AUC of acetone in urine increased by on average 14% (not significant).

The level of toluene in blood increased rapidly initially and then levelled off towards the end of exposure. The uptake of toluene, expressed as absolute net uptake, was significantly increased after chlorzoxazone intake. However, no effects were seen on the AUC of toluene in blood, post-exposure respiratory excretion of toluene or total excretion of hippuric acid in urine. The rate of urinary excretion of the toluene metabolite hippuric acid seemed to be slightly affected by chlorzoxazone. A small decrease in excretion rate during exposure ($p=0.003$) and a small increase 3 h post-exposure (not significant) compared to exposure to toluene alone were seen. The formation and excretion of hippuric acid were merely delayed, with no substantial change in metabolic pathways, indicated by no influence on the cumulative 24-h excretion of hippuric acid.

The concentration of chlorzoxazone in plasma increased from zero to about 27 $\mu\text{mol/L}$ 3 h after intake of 500 mg chlorzoxazone, and decreased thereafter. Similarly, the concentration of the metabolite 6-hydroxychlorzoxazone increased from zero to about 8 $\mu\text{mol/L}$ at 3 h and decreased thereafter. There was an increase in the urinary excretion rate of the chlorzoxazone metabolite 6-hydroxychlorzoxazone from about 1.0 $\mu\text{mol/min}$ at 1 h after chlorzoxazone intake to a maximum of about 1.2 $\mu\text{mol/min}$ at 3 h. Thereafter the excretion rate decreased, and 6-hydroxychlorzoxazone could only be detected in 3 of 10 samples the following morning. The cumulative excretion was in average 0.38 mmol, or 14% (range 5-15%) of the dose. No unchanged chlorzoxazone was found in any urine sample.

A tendency of borderline significance ($p=0.06$) towards increased chlorzoxazone plasma level was caused by acetone coexposure. Further, acetone exposure seemed to cause a decrease in the 6-hydroxychlorzoxazone/chlorzoxazone ratio (metabolic ratio) at 3 h. However, no firm conclusion can be drawn, since only three blood samples were available for metabolite analysis. Further, the excretion of 6-hydroxychlorzoxazone seemed to be slightly delayed after acetone exposure as the rate was decreased in the two early urine samples (not significant) and increased in the three late samples.

A small increase in chlorzoxazone plasma levels ($p=0.05$) was seen after exposure to toluene and chlorzoxazone, compared to chlorzoxazone alone. In addition, plasma 6-hydroxychlorzoxazone and the metabolic ratio at 3 h appeared to be slightly lowered by toluene, although the statistical analysis was inconclusive due to the limited number of samples. In support of these observations, the excretion of 6-hydroxychlorzoxazone seemed to be slightly delayed, in that the rate was decreased in the two early urine samples but increased in the three late samples.

Discussion

After administration of chlorzoxazone there was a slight but significant increase in the AUC of acetone in blood, along with tendencies towards an increased half time in blood and an increased AUC in urine. Taken together, this suggests that chlorzoxazone causes a small inhibition of the acetone metabolism.

In contrast to acetone, toluene toxicokinetics were not significantly affected by chlorzoxazone. However, upon coexposure to chlorzoxazone, the urinary excretion of

hippuric acid, a metabolite of toluene, was delayed, with no change in total excretion. Probably the intrinsic capacity to eliminate toluene is inhibited by chlorzoxazone but this effect is not seen because toluene metabolism is flow limited. This is supported by the high apparent blood clearance of toluene (1.3-1.6 L/min), calculated from the net uptake and the AUC in our experiment. This value is similar to liver blood flow and suggests that the blood flow rather than intrinsic enzyme capacity limits the toluene metabolism.

Both toluene and acetone seemed to cause increases in chlorzoxazone plasma levels along with delayed urinary excretion of the 6-hydroxy metabolite, although this is statistically significant only with respect to toluene. In light of the observation that these interactions are small compared to the inter- and intra-individual variability more subjects will be needed to confirm this effect.

Reliability of CYP2E1 phenotyping by chlorzoxazone (study II)

Study design

The 6-hydroxychlorzoxazone / chlorzoxazone (metabolic) ratio in plasma was measured at 2 h in 27 male and 9 female volunteers following a single oral dose of 500 mg chlorzoxazone. Similarly, the metabolic ratios at 4 h and 6 h were measured in 20 of the males. The metabolic ratio at 2 h was also determined 1.5 and 2.5 years later in 13 and 7 males, respectively, and weekly in 7 males, three times after a dose of 500 mg, once at higher (750 mg) and lower (250 mg) doses, and once (500 mg) following moderate ethanol intake (0.5 g/kg body weight) the preceding evening.

Results

The metabolic ratio ranged from 0.12 to 0.61 at 2 h after intake of chlorzoxazone. There was positive correlation with body weight (both sexes: $r=0.61$, men: $r=0.71$, and women: $r=0.41$) (Figure 10).

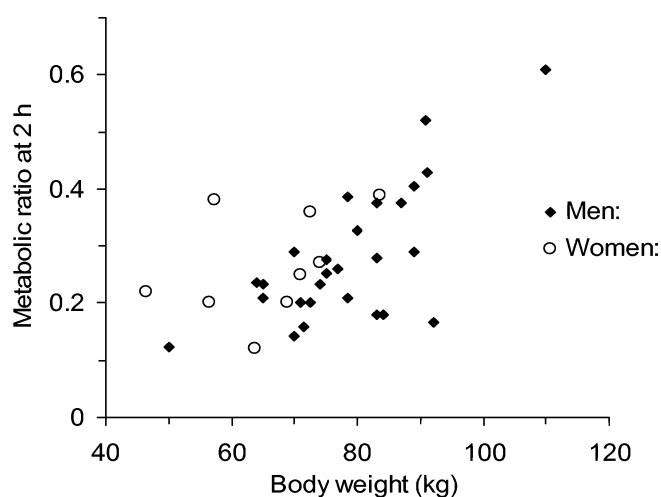

Figure 10. The correlation between the metabolic ratio at 2 h after intake of 500 mg chlorzoxazone and body weight ($n=36$).

The metabolic ratio decreased with increasing chlorzoxazone doses ($p=0.01$). Regarding the intra-individual variability in metabolic ratio, both the long-term (yearly intervals) and the short-term (weekly intervals) were similar. This was also seen in the inter-individual variability. No influence of ethanol intake the preceding evening was seen. Further, there were no significant associations between *CYP2E1* and *GSTM1* genotypes and the metabolic ratio. However, we saw a significant effect of *NAT2* phenotype on the metabolic ratio in that the slow acetylators had a lower average metabolic ratio than the rapid or intermediate acetylators.

The urinary recovery of 6-hydroxychlorzoxazone over 8 h was approximately 55% of the administered dose (500 mg). No association between urinary recovery and metabolic ratio, *NAT2* phenotype or any of the investigated genotypes was found.

Discussion

We found significant correlations between the metabolic ratio and body weight (Figure 10), lean body mass, body fat and body mass index in men and in both sexes combined. The lack of significant correlations among women may be due to the small number of females (only 9) in our study. That body weight is a major contributor to the inter-individual variability in the oral clearance of chlorzoxazone has previously been reported in other studies^{33, 36}.

The high positive correlation to body weight suggested dose dependent metabolism of chlorzoxazone. This is also supported by the decreasing metabolic ratio with the increasing chlorzoxazone dose. The data in our study suggest that the hydroxylation of chlorzoxazone becomes partially saturated at the two higher doses. This can also be seen in the average decreases in metabolic ratio at 2 h of 32% after 500 mg and 58% after 750 mg, compared to 250 mg. This is in agreement with a previous study reporting that the metabolic ratio at 4 h decreases by 48% after 750 mg compared to 250 mg¹¹⁴.

The *CYP2E1* enzyme activity seems to be fairly constant in the individuals since the intra-individual variability was about the same in long-term and short-term experiments. Absorption, distribution and excretion kinetics and analytical errors are several sources that may contribute to this variability. To our knowledge, no other studies have investigated the intra-individual variation for such a long period of time (6 times during 2.5 years). In a study by Bachmann and Sarver¹¹⁵ chlorzoxazone was administered to 6 healthy male subjects on two consecutive weeks and no significant difference in clearance between the two occasions was found. These results support that a single-dose, single-sample procedure may suffice to measure the *CYP2E1* activity when chlorzoxazone is used to determine *CYP2E1* phenotype in humans.

In study II we have considered 2 h after drug administration as the preferred sampling time. In study I we have chosen 3 h as sampling time since it was appropriate to the design of the study. However, in study II we found a high correlation between the metabolic ratios at 2 h and 4 h, suggesting that the latter is also an appropriate sampling time. This is also supported by a study by Frye and colleagues¹¹⁴ where the metabolic

ratios at 2, 3 and 4 h were all significantly correlated to the formation clearance of the hydroxy metabolite.

Moderate intake of alcohol the preceding evening did not influence the metabolic ratio in our study. This was somewhat unexpected since ethanol is a well-known inducer of CYP2E1 (see eg review by Lieber²⁸). In a study by Lucas and colleagues¹¹⁶, alcoholic patients metabolised chlorzoxazone at a five times higher rate than healthy volunteers. Further, in another study by Plee-Gautier and colleagues¹¹⁷ they saw a mean increase of 77% in the metabolic ratio at 2 h, following consumption of 0.8 g/kg ethanol, a 1.6 times higher dose than in the present study. However, a much smaller effect of ethanol has been reported by Oneta and colleagues¹¹⁸. They saw the median metabolic ratio in five male volunteers increasing from 0.48 before ethanol intake to 0.63 after a week of daily intake of 40 g ethanol. The results in our study suggest that moderate intake of alcohol the preceding day does not significantly induce CYP2E1, which is important to note, since subjects are often recommended to avoid alcohol intake for some days before a study.

In study I only about 14% of the chlorzoxazone dose was excreted as 6-hydroxychlorzoxazone conjugate in urine in 22 hours. In study II the urinary recovery of 6-hydroxychlorzoxazone over 8 h accounted for approximately 55% (range 37- 84%) of the administered dose (500 mg) which is similar to the values of 39% to 74% after doses of 250 mg – 750 mg in 10 to 24 h reported by others^{32, 114, 119, 120}. The markedly lower urinary recovery in study I (5- 15%) can be explained by a more variable and, on average, reduced or delayed chlorzoxazone absorption, most likely caused by the intake of morning meal before administration of chlorzoxazone. In the other studies mentioned, and in chlorzoxazone phenotyping studies in general, the subjects had fasted for at least 8 hours before ingesting chlorzoxazone. Considering the extensive demands on the volunteers in study I, including solvent exposure, blood sampling and physical exercise for several hours, we decided to allow them to have breakfast on the day of exposures.

In summary, the metabolic ratio at 2 h after intake of chlorzoxazone appears to be appropriate for CYP2E1 phenotyping. It is advisable to adjust the dose for body weight since the metabolic ratio seems to be dose-dependent. Pre-test restrictions about no intake of alcohol (moderate amounts) are not necessary since it does not seem to affect the metabolic ratio.

Sex differences in toxicokinetics (study III-IV)

Study design

Nine women and 8 men were exposed for 2 h to *m*-xylene (50 ppm), 2-propanol (150 ppm) and to clean air (control exposure) on different occasions during light physical exercise (50 W). *m*-Xylene, 2-propanol, and acetone (a metabolite of 2-propanol) were monitored up to 24 h after exposure in exhaled air, blood, saliva. *m*-Methylhippuric acid (a metabolite of *m*-xylene) was also measured. Body fat and lean body mass (LBM) were estimated. Genotypes and/or phenotypes of cytochromes P450 2E1 and 1A1, GSTM1 and P1 and epoxide hydroxylase were determined.

Results

The toxicokinetic analyses revealed no significant differences in toxicokinetics between subjects of different metabolic genotypes or phenotypes. The following sex differences were significant at the $p=0.05$ level (Student's *t*-test). For both solvents, the respiratory uptake was lower and the volume of distribution smaller in females. The AUC of *m*-xylene in exhaled air post-exposure was larger in women than in men. In addition, the excretion via exhaled air was significantly higher in women when corrected for body weight or LBM. In contrast, the men had a significantly higher excretion of *m*-methylhippuric acid in urine, and AUC of *m*-xylene in urine. The women had a slightly shorter half time of 2-propanol in blood but approximately four times higher 2-propanol levels in exhaled air at 10 min post-exposure and onwards. Furthermore, the women had ten-fold higher *in vivo* blood:breath ratios than men, suggesting sex differences in the lung metabolism of 2-propanol. Following exposure to 2-propanol females had slightly higher concentrations of the metabolite acetone in blood than men. However, this difference was also seen in control experiments. The most marked sex difference was that of salivary acetone, where a more than 100-fold increase was seen in women, but only a minor increase in men, after exposure to 2-propanol compared to clean air (Figure 11).

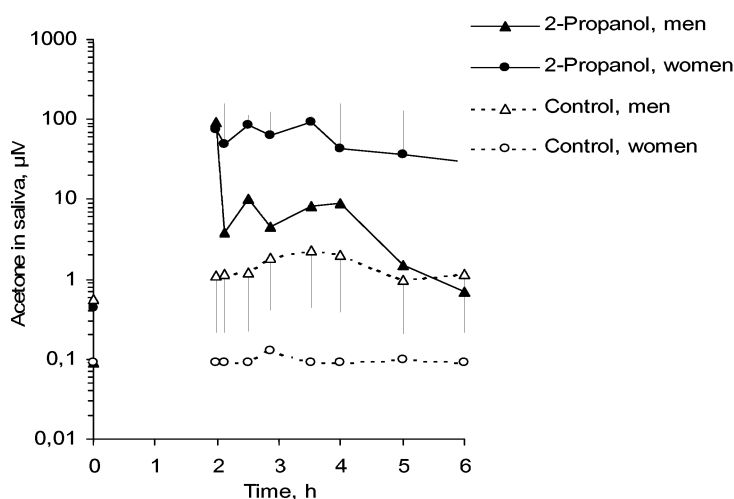

Figure 11. Acetone in saliva after 2 h exposure to 2-propanol (150 ppm).

Discussion

The toxicokinetics of *m*-xylene and 2-propanol in females and males were quite similar regarding respiratory uptake and concentration-time profiles of blood. However, when we corrected for body composition there were significant or borderline significant sex differences in uptake after exposure to both *m*-xylene and 2-propanol. The sex difference in uptake is likely to be a consequence of the experimental design, in that the workload was the same for all subjects (50 W) and

thus higher for small subjects when expressed per kg body weight or lean body mass. The observation is still of interest, since some types of work such as lifting may require greater effort per kg body weight in small subjects.

The males had a significantly higher cumulative excretion of *m*-methylhippuric acid in urine. This is consistent with their higher net uptake of *m*-xylene. The cumulative excretion of *m*-methylhippuric acid corresponded to 49% of the inhaled dose in both sexes. This is in agreement with a study by Ogata and coworkers¹²¹ where they found an excretion of 46% after exposure to *o*-xylene (138 ppm, 3 h).

The ten-fold higher *in vivo* blood:breath ratio in females can hardly be explained by washin-washout phenomena or other diffusion-limited processes. A possible explanation is that 2-propanol is metabolically formed in the lung epithelium. However, the very high *in vivo* ratio in males would then suggest metabolic elimination of 2-propanol in the epithelium. Taken together, this suggests a marked sex difference in metabolic activities in the lungs. Further studies will be needed to confirm this effect and elucidate its health implications.

Acetone is a metabolite of 2-propanol⁹² but is also produced endogenously. Acetone levels may change naturally during the day, for example due to physical exercise or food intake¹²². Following 2-propanol exposure women had higher concentrations of acetone in saliva than men. No such difference was seen in exhaled air. We have no explanation for the marked sex difference, but one may speculate that women have a higher metabolic capacity in the mucosa and/or salivary glands.

Sex differences in acute effects (study V)

Study design

Fifty-six healthy volunteers (28 per sex) were exposed to 150 ppm 2-propanol, 50 ppm *m*-xylene and clean air for two hours at rest. The subjects rated symptoms on a visual analogue scale before, during, and after the exposure. Blinking frequency was measured continuously during exposure. Pulmonary function, nasal swelling, inflammatory markers in nasal lavage and colour vision were measured before and immediately after and 3 h after the exposure.

Results

Females tended to rate symptoms slightly higher than males, independent of exposure. Nearly all symptom ratings increased during solvent exposure, as compared to control exposure in both women and men. These increases were significant for most symptoms at at least one of the two time points 60 min and 118 min. The average ratings during solvent exposure did not exceed that corresponding to “somewhat” on the VAS scale. In women, but not in men, the rating of “discomfort in the throat or airways” was significantly increased after 60 min of exposure to both 2-propanol and *m*-xylene. The rating of “fatigue” was more increased in men after 1 h but more increased in women after 2 h of exposure to *m*-xylene. This rating increased markedly among females also during control exposure.

Regarding pulmonary function, no significant effects of solvent exposure were seen in men. In women, no effect was seen of 2-propanol, whereas FVC was decreased and FEV1/FVC and FEF₇₅ were increased at 3 h after exposure to *m*-xylene. The only significant sex difference was that women had a more marked decrease in FVC than men 3 h after exposure to *m*-xylene (Figure 12).

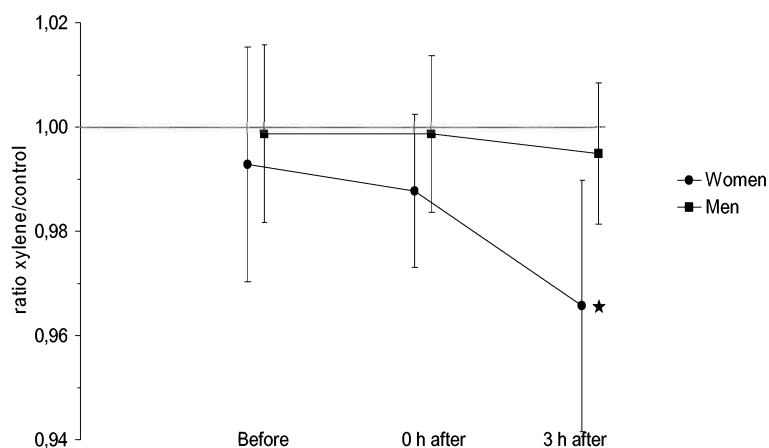

Figure 12. Forced vital capacity (FVC), before, immediately after and 3 h after exposure to *m*-xylene.

With respect to lung diffusing capacity for carbon monoxide, there was a significant sex difference in response between exposure conditions, as analysed by ANOVA. Men showed a tendency but not significant to an increase in DLco after exposure to 2-propanol and women showed a tendency to an increase after exposure to *m*-xylene.

No significant effects of solvent exposure on nasal volume or cross-sectional area were seen. However, according to the ANOVA analysis there was a tendency to a sex dependent decrease in nasal volume during the day. The decrease was more pronounced in women.

Regarding inflammatory markers in nasal lavage, no significant differences between sexes, or effects of exposure to 2-propanol or *m*-xylene, were seen. However, the average levels of myeloperoxidase and albumin increased by about 20-50% in women exposed to 2-propanol or *m*-xylene.

In blinking frequency there were no significant differences between sexes or effects of exposure. The ANOVA revealed a significant change in frequency over time, which may be explained by increased alertness due to entering a new environment.

With respect to colour vision, unexposed women performed better in the test (i.e. lower CCI) than unexposed men. A tendency to a sex-dependent difference in CCI response in the ANOVA analysis was seen. Both women and men had a non-significant tendency to increased CCI after exposure to 2-propanol and in men also after exposure

to *m*-xylene as compared to clean air. Women exposed to *m*-xylene, however, tended to improve their colour vision.

Discussion

This study was performed to test the hypothesis that women and men differ in their sensitivity to the acute effects of two common solvents, 2-propanol and *m*-xylene. The result of the average ratings prior to exposure suggests that women tend to give higher symptom intensity ratings than men. This is supported by other studies⁸⁰⁻⁸¹. One explanation to the higher symptom ratings among women in our present study could thus be that women expect to be exposed to a stressful and potentially toxic environment. In addition, we saw significantly increased ratings for nearly all symptoms following solvent exposure as compared to clean air exposure in both women and men. This has been seen in other studies too^{55, 123-124}.

A small effect on the lung function of women exposed to *m*-xylene was detected. We also noted a diurnal variation in lung function; this variation was more pronounced in women. An explanation might be that, on average, women are smaller than men and have smaller airways, which are more sensitive to swelling.

We saw indications of a tendency to a sex difference in the decrease of nasal volume during the day, with the females having a larger relative decrease. This tendency was found under all three exposure conditions, including clean air. Further, a tendency to a small sex difference in minimal cross-sectional area was observed, as also seen by Millqvist and Bende¹²⁵. An explanation for this could be that the females have a smaller nasal cavity than the males, and that the same degree of mucosal swelling thus causes a greater relative decrease in volume and area in women.

To get an objective indicator of eye irritation we measured eye blinks with electromyography (EMG). Increased blinking may be an early marker of eye irritation from exposure to irritating pollutants. During the second hour of exposure to 2-propanol there was a tendency to an increased blinking frequency in females (not significant). This is in agreement with the increased rating of irritative symptoms in females exposed to 2-propanol. The blinking frequency was increased, during the first minutes in the exposure chamber at all exposure conditions. This is probably due to increased alertness and can be considered as an "adaptation phase".

A significantly higher CCI among unexposed men compared to unexposed women was found. The well-known higher prevalence of colour blindness among men cannot explain our finding since subjects with known congenital colour vision defects were excluded and there was no bimodal distribution in CCI, which would indicate subclinical colour blindness. This is the first study, to our knowledge, indicating that women may have better colour vision than men.

In summary, the results suggest that females are slightly more sensitive than men to the acute irritative effects of vapours of 2-propanol and *m*-xylene.

GENERAL DISCUSSION

In this thesis several factors such as sex, drug, and CYP2E1, which might influence the toxicokinetics of organic solvents were studied. Sex differences in the acute effects of organic solvents were also addressed. Sex differences are important to study since toxicokinetic studies in women are scarce. When studying sex differences there are some aspects that have to be taken into account, for example body build and sex hormones.

The physiological characteristics of females differ from those of males: there are differences not only in size and weight, but also in percentage of body fat, internal organ dimensions, breathing rates, and total body blood volume. The differences in average body composition may cause significant sex differences in toxicokinetics. Differences between females and males in ethanol kinetics have been discussed⁷⁵⁻⁷⁶. The sex difference is partly explained by body build and the remaining difference is due to a smaller gastric metabolism of ethanol in women⁷⁵. Possible sex differences in the gut metabolism are not expected to be of any significant importance in the present study since the volunteers were exposed via the air. In study III and IV we were able to demonstrate some sex differences in the toxicokinetics of *m*-xylene and 2-propanol. Almost all of these differences were consistent with anatomical sex differences but not the differences in 2-propanol levels in expired air and acetone in saliva. Further investigations will be needed to confirm and characterise these effects and elucidate their health implications.

Since sex hormones, the phase of the menstrual cycle, and oral contraceptive steroid administration may influence the toxicokinetics of solvents, one of the inclusion criteria was that the women not use oral contraceptives. The women were exposed at any point of the menstrual cycle. However, each woman was always exposed at the same phase of her cycle. In study III and IV we also measured sex hormone levels (testosterone, prolactin and sex hormone binding globulin) before and after the exposure. The results (unpublished) showed that the diurnal variation of the hormones was much larger than the influence of exposure.

A sex difference in CYP2E1 activity has previously been suggested, with higher clearance of chlorzoxazone in men compared with women^{31,65}. However, in our study (II) no sex difference in metabolic ratio was seen. Women had a range of metabolic ratios similar to those of the men, in spite of lower body weights. The effect of sex was more pronounced when metabolic ratios were plotted against lean body mass. No such difference would be expected if the metabolic ratio mainly depends on absorption, distribution, or excretion phenomena or if CYP2E1 activity is only related to liver size. In contrast, the sex difference disappeared when plotting metabolic ratio against body fat mass which may indicate that the metabolic ratio is mainly related to CYP2E1 activity.

In the present thesis only Caucasians were included, to prevent variation in the metabolic capacity due to ethnicity. Inter-ethnic differences have been demonstrated for CYP2E1¹²⁶. Individuals with the c2 allele (rare alleles) had a lower CYP2E1 activity³³. The rare allele is more common among the Japanese than among

Caucasians. Ethnic differences have also been demonstrated for ADH. Polymorphism is common in the *ADH1B* (ADH2) gene, and results in less efficient metabolism of ethanol in many individuals of Oriental origin, although it is uncommon in Caucasians¹²⁷.

Concerning CYP2E1 phenotyping with chlorzoxazone, CYP1A¹²⁸⁻¹³⁰ and CYP3A4¹²⁹ have been suspected to contribute to the metabolism of chlorzoxazone. However, Lucas and colleagues¹³¹ have studied smokers and non-smokers and showed that the contribution of CYP1A to the metabolism of chlorzoxazone *in vivo* is not important. In the same study, Lucas and colleagues also investigated the contribution of CYP3A4 to chlorzoxazone 6-hydroxylation and found that less than 3% of total activity was attributed by CYP3A4¹³¹.

An advantage in chamber exposure studies is that volunteers are exposed to solvents under well-controlled conditions. The solvent exposure level and duration as well as work load, temperature, and humidity are all controlled. A further strength is that the subjects serve as their own controls, excluding effects due to individual differences in physiological parameters. However, the comparatively low exposure levels below or equal to the occupational exposure limit value (8-h time-weighted average) reduce the power to detect any differences or effects if they exist. Further limitations are the small number of subjects that can be studied and the high experimental costs. In addition, a problem with the recruiting process is that one may expect an under-representation of individuals who dislike the smell or have other negative experiences of solvents and chemicals in general. When studying differences between women and men, there is a possibility that the participating women to a different extent than the participating men were recruited from “unafraid” sub-groups of the population. If this is the case, a true sex difference in solvent sensitivity may be reduced.

The limited number of subjects with few individuals having the rare genotypes may also have been a problem in the study on reliability of CYP2E1 phenotyping where we found no significant influence of the investigated polymorphisms in *CYP2E1* on the metabolic ratio or urinary metabolite recovery.

In study III and IV we have taken saliva samples. Saliva and blood levels of *m*-xylene and 2-propanol were parallel and correlated fairly well. This was also seen in a study of methanol (unpublished). The saliva sampling technique is simple and non-invasive, making it useful as a way to sample for biomarkers of exposure to solvents. Acetone in saliva has previously been proposed as a biomarker of exposure to 2-propanol by Rose and colleagues¹³². They have found a relatively high correlation of 0.86 between acetone in blood and saliva. However, we obtained a much lower correlation of 0.46. The main reason for the lower correlation in our study is probably that we got a higher contribution of variable background levels of acetone. Other differences may also have contributed, such as longer sampling period (10 min vs 1 min), and different sampling schemes. To further investigate the usefulness of saliva samples for measurement of biomarkers of exposure to solvents is one of my plans for the future.

CONCLUSIONS

Drug influence on toxicokinetics

- Chlorzoxazone treatment does not result in clinically significant effects on acetone or toluene disposition. However, indications of a slightly decreased biotransformation of acetone and possibly also of toluene after intake of chlorzoxazone were found.
- Both acetone and toluene seem to delay the metabolism of chlorzoxazone.
- The most likely explanation for the effects is competitive inhibition of CYP2E1, since all three substances are substrates for this enzyme.

Phenotyping of CYP2E1 with chlorzoxazone

- The metabolism of chlorzoxazone in an individual is relatively stable over time.
- The metabolic ratio is dose-dependent; therefore it is advisable to adjust the dose by body weight.
- Moderate intake of ethanol does not seem to affect the metabolic ratio.
- Two hours after chlorzoxazone intake appears to be an appropriate sampling time for determination of the metabolic ratio.

Sex differences in toxicokinetics

- Small differences between women and men in the toxicokinetics of 2-propanol and *m*-xylene in humans were demonstrated.
- Most of these differences are consistent with anatomical sex differences, such as body weight and body fat content.
- However, body build cannot explain the difference between women and men regarding 2-propanol in expired air and acetone in saliva.

Sex differences in acute effects

- There were no significant sex differences in blinking frequency, lung diffusing capacity, nasal area and volume, inflammatory markers in nasal lavage, or colour vision after exposure to solvents.
- Increased symptoms were reported by both sexes for nearly all 10 questions during exposure to 2-propanol or *m*-xylene. The rating of "discomfort in the throat or airways" increased more in women during exposure to 2-propanol or *m*-xylene.
- Regarding pulmonary function, women had small but significant decreases in FVC, FEV₁/FVC and FEF₇₅ 3 h after exposure to *m*-xylene, but only the decrease in FVC was significantly different from that in men.
- Our results suggest that women are slightly more sensitive than men to the acute irritative effects of 2-propanol and *m*-xylene vapours.

SAMMANFATTNING (SUMMARY IN SWEDISH)

Människan utsätts för kemiska ämnen genom exempelvis exponering i arbetet. I dag förekommer tiotusentals kemikalier varav flertalet inte är utredda vad det gäller hälsoeffekter. En viktig uppgift inom arbetslivsforskningen är att ta fram kunskap om kemiska ämnen och deras effekt på människokroppen. Den tidigaste effekten av många kemiska ämnen är irritation av ögon och slemhinnor eller påverkan på nervsystemet. Det kan vara svårt att mäta tidiga tecken och utveckling av känsligare metoder för sådan påverkan är därmed viktig. Det finns faktorer som kan påverka hur kemiska ämnen tas upp och omvandlas i kroppen tex kön, kroppsbyggnad, arbetsbelastning läkemedels- och alkoholintag. Detta kan ge ett förändrat upptag och en förändrad omsättning av ett kemiskt ämne och därmed även förändra risken för hälsoeffekter.

Den huvudsakliga målsättningen med avhandlingen var att på människa studera:

- inverkan av klorzoxazon på upptag och omsättning av lösningsmedelsånga
- inverkan av kroppsbyggnad, variation över tid, alkoholintag och dos, på fenotypning av CYP2E1 med klorzoxazon
- inverkan av kön på upptag och omsättning av lösningsmedelsånga
- inverkan av kön på akuta effekter av lösningsmedelsånga

En del läkemedel biotransformeras i kroppen via samma enzymssystem som många kemikalier. Detta kan påverka upptag och omsättning av ett ämne när man äter medicin, och därmed förändras även risken för hälsoeffekter. I studie I exponerades frivilliga försökspersoner för lösningsmedlen toluen och aceton med och utan intag av läkemedlet Paraflex® (klorzoxazon) i en exponeringskammare. Lösningsmedlen mättes i inandningsluft, utandningsluft, kapillärblod och urin. Halten klorzoxazon och dess metabolit 6-hydroxyklorzoxazon samt hippursyra, en metabolit till toluen, analyserades också. Studien visade att klorzoxazon behandling inte hade någon större effekt på dispositionen av aceton och toluen. En något fördröjd biotransformation av aceton och möjligen också av toluen efter intag av klorzoxazon observerades. Både aceton och toluen fördröjde metabolismen av klorzoxazon något. Detta visar troligen på en konkurrens om enzymet eftersom alla tre ämnena är substrat för cytokrom P450 2E1 (CYP2E1).

Många industrikemikalier biotransformeras via enzymet CYP2E1. Variationen i CYP2E1-aktiviteten är stor mellan olika individer och den individuella enzymaktiviteten kan påverkas av omgivningsfaktorer, såsom exponering för lösningsmedel, alkoholintag och komponenter i födan, varför också aktiviteten kan tänkas variera över tid. Frivilliga försökspersoner intog läkemedlet, varefter blodprov togs vid olika tidpunkter. I proverna analyserades klorzoxazon och dess metabolit 6-hydroxyklorzoxazon. För att studera om klorzoxazonmetabolismen är konstant över tiden upprepades denna mätning ca 1,5 och 2,5 år efter det första tillfället. För att studera hur testsvaret varierar under en kortare tid (veckor), om testsvaret är dosberoende och om det påverkas av smärre alkohol intag testades försökspersonerna vid tre olika doser, under tre veckor samt efter intag av alkohol motsvarande ca en halv flaska vin dagen innan. Studien visade på en positiv korrelation till kroppsvikten vilket tyder på en dosberoende metabolism av klorzoxazon. Mellan- och inom- individ

variationen var lika stor under lång (år) och kort tid (veckor). Försöket med olika doser visade på en sjunkande metabolisk kvot med högre dos, vilket också tyder på en dosberoende metabolism av klorzoxazon. Måttligt intag av alkohol påverkade inte testsvaret. Sammanfattningsvis kan man säga att metabolismen av klorzoxazon var relativt konstant över tiden, men att den är dosberoende och man bör därför korrigera dosen för kroppsvikt.

Under senare år har kvinnor i större utsträckning börjat arbeta inom industrin och de utsätts numera för kemiska ämnen i nästan samma omfattning som män. I Sverige är ungefär en tredjedel av de som exponeras kvinnor. Bedömning av kemiska hälsorisker samt hygieniska gränsvärden och annan reglering är dock nästan helt baserade på studier av män. Arbetsmiljöforskningen utgår således ofta från mäns arbeten och hälsoförhållanden och förutsätter att samma mönster och reaktioner även gäller för kvinnor. Detta medför risk för allvarliga felbedömningar om det är så att kvinnor är känsligare än män. I studie III-V exponerades frivilliga försökspersoner i en exponeringskammare för två vanliga lösningsmedel, *m*-xylen och isopropanol under två timmar vid det svenska nivågränsvärdet för att studera könsskillnader i akuta effekter samt inverkan av kön på upptag och omsättning av lösningsmedelsånga. Akuta effekter som mättes inkluderade blinkfrekvens, lungfunktion, nässvullnad, färgseende och inflammationsmarkörer i nässköljvätska, och symtomskattningar gjordes med visuell analog skala (VAS). Kroppsmåtten bestämdes genom mätning av kroppsfett, vikt och längd. Lösningsmedlen och deras nedbrytningsprodukter mättes i inandningsluft, utandningsluft, kapillärblod, saliv och urin. Biotransformationsförmågan mättes genom fenotypning av CYP2E1 med klorzoxazon-metoden samt genom genotypning av en rad andra biotransformationsenzymer. Studien visade att kvinnorna tenderade att skatta upplevda besvär högre än männen men det var ingen större skillnad mellan könen i symtomökning om man jämför kontrolexponering och lösningsmedelsexponering. Kvinnorna hade en tendens till försämrad lungfunktion efter exponering för xylen. Upptaget via luftvägarna var högre och distributionsvolymen var större hos männen. Kvinnorna hade en något kortare halveringstid av isopropanol i blod och cirka fyra gånger högre halter av isopropanol i utandningsluft än männen. Den mest anmärkningsvärda könsskillnaden var en cirka 100-faldig ökning av aceton i saliv efter isopropanol-exponering jämfört med kontroll-exponeringen hos kvinnorna. Vi såg ingen signifikant inverkan av genotyp/fenotyp på upptag och omsättning av lösningsmedlen. Sammanfattningsvis så kan en del av de observerade skillnaderna förklaras med att kvinnorna är mindre än männen och har en större andel fett. Emellertid kan inte skillnaderna i kroppsbyggnad förklara könsskillnaden av aceton i saliv och isopropanol i utandningsluft.

ACKNOWLEDGEMENTS

This work was mainly performed at the National Institute for Working Life. Besides the financial support from the National Institute for Working Life, we were financially sponsored by the Swedish Council for Working Life Research (Studies II – V).

I would like to thank my supervisors:

First of all, my tutor and supervisor, **Gunnar Johanson**. Thank you for your patience and wholehearted support during all these years. Although you are busy and have a lot of other things to do, you always take time to make a lot of changes in my manuscripts.

I want to give my warmest thanks to my former supervisor, **Agneta Löf**, for always in a kind manner answering all my questions. It was you and Gunnar that made me start with this thesis, for better and worse.

Anders Iregren, for always having time to share your knowledge in statistics and to share a cup of coffee early in the morning.

Lena Palmberg, for being supportive whenever needed and for teaching me a lot about acute effects.

Margareta Warholm, for initiating me into the world of genotypes and phenotypes. Further, for accompanying me to the gym, aerobics and to the swimming pool.

I would like to thank all my colleagues and especially:

First of all, my colleague in all the chamber experiments and one of my best friends who unfortunately and surprisingly died in January 2001, **Elisabeth Gullstrand**. I miss her so much.

Bengt Sjögren, "my doctor" and co-writer is acknowledged for medical examinations of subjects and medical responsibilities during exposures. Further, for training with me in first aid and for being a nice friend.

Fredrik Jonson, I would like to thank you for invaluable help with the NONMEM analysis.

There are a lot of colleagues and friends at National Institute for Working Life that I have been in contact with during the studies and I want to thank all of you wherever you are.

I also want to give many thanks to all **volunteers**, for letting me take samples and analyse your bodies in a lot of ways and for trusting in us during the experiments. Without you, this thesis would not have been done.

I would like to thank my family and friends, for never falling asleep during my endless speeches about my work, and especially to:

My dad, **Sven** for being so proud of me and for have supported me all my life.

Finally, and the best in my life, my husband, **Jonte**, for his love and support in daily life. **Håkan** and **Anna**, our children, for their patience with their constantly “studying” mother.

REFERENCES

1. Stacey NH. Occupational toxicology. 1993, London: Taylor & Francis.
2. Tanaka E. Gender-related differences in pharmacokinetics and their clinical significance. *J Clin Pharm Ther* 1999;245:339-46.
3. Environment News Service. Toxic substances put one in five EU workers at risk. 26 August 2003.
4. Järholm B. In Swedish, Yrkessjukdommar -förekomst och farlighet, in *Arbetsliv och Hälsa*, S. Marklund, Editor. 2000: Stockholm. p. 289-302.
5. Swedish Work Environment Authority. In Swedish, Lösningsmedel (solvents). 9 February 2001.
6. Statistics 2001. Statistics Sweden.
7. Axelson O, Hogstedt C. The health effects of solvents, in *Occupational Medicine*, C. Zenz, Editor. 1994, Mosby: St. Louise. p. 764-778.
8. Klaassen CD, Doull J. Evaluation of safety: toxicologic evaluation. Cassarett and Doull's Toxicology, ed. Klassen, J. Doull, C.D. Amdur, M.O. 1975, New York: Macmillan Publishing Co. Inc. 11-27.
9. Rowland M, Tozer TN. *Clinical Pharmacokinetics, Concepts and Applications*. 1995, Philadelphia: Lea & Febiger.
10. Holmberg B, Högberg J, Johanson G. General principles of toxicology: Definitions and concepts, in *Encyclopaedia of Occupational Health and Safety*, J.M. Stellman, Editor. 1997: International Labour Office, Geneva Switzerland. p. 33.3-33.7.
11. Johanson G, Filser JG. Experimental data from closed chamber gas uptake studies in rodents suggest lower uptake rate of chemical than calculated from literature values on alveolar ventilation. *Arch Toxicol* 1992;664:291-5.
12. Löf A, Johanson G. Toxicokinetics of organic solvents: a review of modifying factors. *Crit Rev Toxicol* 1998;286:571-650.
13. Guengerich FP, Kim D-H, Iwasaki M. Role of human cytochrome P-450 IIE1 in the oxidation of many low molecular weight cancer suspects. *Chem Res Toxicol* 1991;4:168-179.
14. Yang CS, Yoo J-S H, Ishizaki H, Hong J. Cytochrome P450IIE1: Roles in nitrosamine metabolism and mechanism of regulation. *Drug Metabolism Reviews* 1990;22:147-159.
15. Tassaneeyakul W, Birkett DJ, Edwards JW, Veronese ME, Tukey RH, Miners JO. Human cytochrome P450 isoform specificity in the regioselective metabolism of toluene and o-, m- and p-xylene. *J Pharmacol Exp Ther* 1996;2761:101-8.
16. Gibson GG, Skett P. *Introduction to drug metabolism*. Second edition ed. 1994, Glasgow: Blackie Academic & Professional.

17. Gobba F, Ghittori S, Imbriani M, Maestri L, Capodaglio E, Cavalleri A. The urinary excretion of solvents and gases for the biological monitoring of occupational exposure: a review. *Sci Total Environ* 1997;1991-2:3-12.
18. Sato A, Johanson G. Physiological factors affecting the behavior of organic solvent vapors in humans, in *High hazard pollutants*, P. Cheremisinoff, Editor. 1995, Gulf Publishing Company: Houston, Texas. p. 53–85.
19. Åstrand I. Uptake of solvents in the blood and tissues of man. A review. *Scand J Work Environ Health* 1975;14:199-218.
20. Åstrand I, Engström J, Övrum P. Exposure to xylene and ethylbenzene. I. Uptake, distribution and elimination in man. *Scand J Work Environ Health* 1978;43:185-94.
21. Wigaeus E, Holm S, Åstrand I. Exposure to acetone: Uptake and elimination in man. *Scand J Work Environ Health* 1981;7:84-94.
22. Pezzagno G, Imbriani M, Ghittori S, Capodaglio E. Urinary concentration, environmental concentration, and respiratory uptake of some solvents: effect of the work load. *Am Ind Hyg Assoc J* 1988;4911:546-52.
23. Kawamoto T, Koga M, Murata K, Matsuda S, Kodama Y. Effects of ALDH2, CYP1A1, and CYP2E1 genetic polymorphisms and smoking and drinking habits on toluene metabolism in humans. *Toxicol Appl Pharmacol* 1995;1332:295-304.
24. Bosron WF, Li TK. Catalytic properties of human liver alcohol dehydrogenase isoenzymes. *Enzyme* 1987;371-2:19-28.
25. Caldwell J, Gardner I, Swales N. An introduction to drug disposition: the basic principles of absorption, distribution, metabolism, and excretion. *Toxicol Pathol* 1995;232:102-14.
26. Raucy JL. Risk assessment: toxicity from chemical exposure resulting from enhanced expression of CYP2E1. *Toxicology* 1995;1052-3:217-24.
27. Kim H, Wang RS, Elovaara E, Raunio H, Pelkonen O, Aoyama T et al. Cytochrome P450 isozymes responsible for the metabolism of toluene and styrene in human liver microsomes. *Xenobiotica* 1997;277:657-65.
28. Lieber CS. Cytochrome P-4502E1: Its physiological and pathological role. *Physiol Rev* 1997;772:517-544.
29. Yoo JS, Guengerich FP, Yang CS. Metabolism of N-nitrosodialkylamines by human liver microsomes. *Cancer Res* 1988;486:1499-504.
30. Hunt CM, Strater S, Stave GM. Effect of normal aging on the activity of human hepatic cytochrome P450 IIE1. *Biochem Pharmacol* 1990;407:1666-9.
31. Kim RB, O'Shea D. Interindividual variability of chlorzoxazone 6-hydroxylation in men and women and its relationship to CYP2E1 genetic polymorphisms. *Clin Pharmacol Ther* 1995;576:645-55.
32. Girre C, Lucas D, Hispard E, Menez C, Dally S, Menez J-F. Assessment of cytochrome P4502E1 induction in alcoholic patients by chlorzoxazone pharmacokinetics. *Biochem Pharmacol* 1994;479:1503-1508.

33. Le Marchand L, Wilkinson GR, Wilkens LR. Genetic and dietary predictors of CYP2E1 activity: a phenotyping study in Hawaii Japanese using chlorzoxazone. *Cancer Epidemiol Biomarkers Prev* 1999;86:495-500.
34. Haufroid V, Buchet JP, Gardinal S, Lison D. Cytochrome P4502E1 phenotyping by the measurement of the chlorzoxazone metabolic ratio: assessment of its usefulness in workers exposed to styrene. *Int Arch Occup Environ Health* 2002;757:453-8.
35. Nomura F, Itoga S, Uchimoto T, Tomonaga T, Nezu M, Shimada H et al. Transcriptional activity of the tandem repeat polymorphism in the 5'-flanking region of the human CYP2E1 gene. *Alcohol Clin Exp Res* 2003;278 Suppl:42S-46S.
36. McCarver DG, Byun R, Hines RN, Hichme M, Wegenek W. A genetic polymorphism in the regulatory sequences of human CYP2E1 - association with increased chlorzoxazone hydroxylation in the presence of obesity and ethanol intake. *Toxicol Appl Pharmacol* 1998;1521:276-281.
37. Haufroid V, Buchet JP, Gardinal S, Ghittori S, Imbriani M, Hirvonen A et al. Importance of genetic polymorphisms of drug-metabolizing enzymes for the interpretation of biomarkers of exposure to styrene. *Biomarkers* 2001;63:236-249.
38. Iwahashi K, Ameno K, Kinoshita H, Nakamura K, Miyatake R, Suwaki H et al. CYP2E1, ALDH2 and ADH2 genotypes and blood ethanol elimination kinetics. *Clin Chim Acta* 1996;2551:85-7.
39. Nakajima M, Yoshida R, Shimada N, Yamazaki H, Yokoi T. Inhibition and inactivation of human cytochrome P450 isoforms by phenethyl isothiocyanate. *Drug Metab Dispos* 2001;298:1110-3.
40. O'Shea D, Davis SN, Kim RB, Wilkinson GR. Effect of fasting and obesity in humans on the 6-hydroxylation of chlorzoxazone: a putative probe of CYP2E1 activity. *Clin Pharmacol Ther* 1994;564:359-67.
41. Dilger K, Metzler J, Bode JC, Klotz U. CYP2E1 activity in patients with alcoholic liver disease. *J Hepatol* 1997;276:1009-14.
42. Kharasch ED, Thummel KE, Mhyre J, Lillibridge JH. Single-dose disulfiram inhibition of chlorzoxazone metabolism: a clinical probe for P450 2E1. *Clin Pharmacol Ther* 1993;536:643-50.
43. Twele R, Spitteller G. [Identification of chlorzoxazone metabolites in human urine (author's transl)]. *Arzneimittelforschung* 1982;327:759-63.
44. Peter R, Böcker R, Beaune PH, Iwasaki M, Guengerich FP, Yang C. Hydroxylation of chlorzoxazone as a specific probe for human liver cytochrome P-450 IIE1. *Chem Res Toxicol* 1990;3:566-573.
45. Löf A, Wallen M, Wigeaus Hjelm E. Influence of paracetamol and acetylsalicylic acid on the toxicokinetics of toluene. *Pharmacol Toxicol* 1990;66:138-141.
46. Campbell L, Wilson HK, Samuel AM, Gompertz D. Interactions of m-xylene and aspirin metabolism in man. *Br J Ind Med* 1988;452:127-32.

47. Mergler D, Blain L. Assessing color vision loss among solvent-exposed workers. *Am J Ind Med* 1987;122:195-203.
48. Muttray A, Wolff U, Jung D, Konietzko J. Blue-yellow deficiency in workers exposed to low concentrations of organic solvents. *Int Arch Occup Environ Health* 1997;706:407-12.
49. Gonzalez M, Velten M, Cantineau A. Increased acquired dyschromatopsia among solvent-exposed workers: an epidemiology study on 249 employees of an aluminum-foil printing factory. *Int Arch Occup Environ Health* 1998;715:317-24.
50. Semple S, Dick F, Osborne A, Cherrie JW, Soutar A, Seaton A et al. Impairment of colour vision in workers exposed to organic solvents. *Occup Environ Med* 2000;579:582-7.
51. Gobba F, Galassi C, Imbriani M, Ghittori S, Candela S, Cavalleri A. Acquired dyschromatopsia among styrene-exposed workers [see comments]. *J Occup Med* 1991;337:761-5.
52. Gobba F, Cavalleri A. Kinetics of urinary excretion and effects on colour vision after exposure to styrene. *IARC Sci Publ* 1993;127:79-88.
53. Campagna D, Mergler D, Huel G, Belanger S, Truchon G, Ostiguy C et al. Visual dysfunction among styrene-exposed workers. *Scand J Work Environ Health* 1995;215:382-90.
54. Mergler D, Huel G, Belanger S, Bowler RM, Truchon G, Drolet D et al. Surveillance of early neurotoxic dysfunction. *Neurotoxicology* 1996;173-4:803-12.
55. Baelum J, Andersen IB, Lundqvist GR, Molhave L, Pedersen OF, Vaeth M et al. Response of solvent-exposed printers and unexposed controls to six-hour toluene exposure. *Scand J Work Environ Health* 1985;114:271-80.
56. Sethre T, Laubli T, Berode M, Krueger H. Neurobehavioural effects of experimental isopropanol exposure. *Int Arch Occup Environ Health* 2000;732:105-12.
57. Bakinson MA, Jones RD. Gassings due to methylene chloride, xylene, toluene, and styrene reported to Her Majesty's Factory Inspectorate 1961-80. *Br J Ind Med* 1985;423:184-90.
58. Harving H, Dahl R, Mölhave L. Lung function and bronchial reactivity in asthmatics during exposure to volatile organic compounds. *Am Rev Respir Dis* 1991;1434 Pt 1:751-4.
59. Borsboom GJ, van Pelt W, van Houwelingen HC, van Vianen BG, Schouten JP, Quanjer PH. Diurnal variation in lung function in subgroups from two Dutch populations: consequences for longitudinal analysis. *Am J Respir Crit Care Med* 1999;1594 Pt 1:1163-71.
60. Ekenvall L, Härenstam A, Karlqvist L, Nise G, Vingård E. [The woman in the scientific study--does she exist?]. *Läkartidningen* 1993;9043:3773-6.
61. Gleiter CH, Gundert-Remy U. Gender differences in pharmacokinetics. *Eur J Drug Metab Pharmacokinet* 1996;212:123-8.

62. Sato A, Nakajima T, Fujiwara Y, Murayama N. Kinetic studies on sex difference in susceptibility to chronic benzene intoxication--with special reference to body fat content. *Br J Ind Med* 1975;324:321-8.
63. Harris RZ, Benet LZ, Schwartz JB. Gender effects in pharmacokinetics and pharmacodynamics. *Drugs* 1995;502:222-39.
64. Schwartz JB. The influence of sex on pharmacokinetics. *Clin Pharmacokinet* 2003;422:107-21.
65. Lucas D, Menez C, Girre C, Berthou F, Bodenez P, Joannet I et al. Cytochrome P450 2E1 genotype and chlorzoxazone metabolism in healthy and alcoholic Caucasian subjects. *Pharmacogenetics* 1995;55:298-304.
66. Kalow W, Tang BK. Use of caffeine metabolite ratios to explore CYP1A2 and xanthine oxidase activities. *Clin Pharmacol Ther* 1991;505 Pt 1:508-19.
67. Bock KW, Schrenk D, Forster A, Griese EU, Morike K, Brockmeier D et al. The influence of environmental and genetic factors on CYP2D6, CYP1A2 and UDP-glucuronosyltransferases in man using sparteine, caffeine, and paracetamol as probes. *Pharmacogenetics* 1994;44:209-18.
68. Relling MV, Lin JS, Ayers GD, Evans WE. Racial and gender differences in N-acetyltransferase, xanthine oxidase, and CYP1A2 activities. *Clin Pharmacol Ther* 1992;526:643-58.
69. Krecic-Shepard ME, Barnas CR, Slimko J, Jones MP, Schwartz JB. Gender-specific effects on verapamil pharmacokinetics and pharmacodynamics in humans. *J Clin Pharmacol* 2000;403:219-30.
70. Lew KH, Ludwig EA, Milad MA, Donovan K, Middleton E, Jr., Ferry JJ et al. Gender-based effects on methylprednisolone pharmacokinetics and pharmacodynamics. *Clin Pharmacol Ther* 1993;544:402-14.
71. Hulst LK, Fleishaker JC, Peters GR, Harry JD, Wright DM, Ward P. Effect of age and gender on tirilazad pharmacokinetics in humans. *Clin Pharmacol Ther* 1994;554:378-84.
72. Miners JO, Attwood J, Birkett DJ. Influence of sex and oral contraceptive steroids on paracetamol metabolism. *Br J Clin Pharmacol* 1983;165:503-9.
73. Wilson K. Sex-related differences in drug disposition in man. *Clin Pharmacokinet* 1984;93:189-202.
74. Thurmann PA, Hompesch BC. Influence of gender on the pharmacokinetics and pharmacodynamics of drugs. *Int J Clin Pharmacol Ther* 1998;3611:586-90.
75. Baraona E, Abittan CS, Dohmen K, Moretti M, Pozzato G, Chayes ZW et al. Gender differences in pharmacokinetics of alcohol. *Alcohol Clin Exp Res* 2001;254:502-7.
76. Kwo PY, Ramchandani VA, O'Connor S, Amann D, Carr LG, Sandrasegaran K et al. Gender differences in alcohol metabolism: relationship to liver volume and effect of adjusting for body mass. *Gastroenterology* 1998;1156:1552-7.
77. Frezza M, di Padova C, Pozzato G, Terpin M, Baraona E, Lieber CS. High blood alcohol levels in women. The role of decreased gastric alcohol

- dehydrogenase activity and first-pass metabolism. *N Engl J Med* 1990;322:95-9.
78. Schwartz J, Katz SA, Fegley RW, Tockman MS. Sex and race differences in the development of lung function [see comments]. *Am Rev Respir Dis* 1988;138:1415-21.
 79. Kroenke K, Spitzer RL. Gender differences in the reporting of physical and somatoform symptoms. *Psychosom Med* 1998;60:150-5.
 80. Tibblin G, Bengtsson C, Furunes B, Lapidus L. Symptoms by age and sex. The population studies of men and women in Gothenburg, Sweden. *Scand J Prim Health Care* 1990;8:9-17.
 81. Pennebaker JW. Psychological bases of symptom reporting: perceptual and emotional aspects of chemical sensitivity. *Toxicol Ind Health* 1994;10:497-511.
 82. Johanson G, Boman A. Percutaneous absorption of 2-butoxyethanol vapour in human subjects. *Br J Ind Med* 1991;48:788-92.
 83. Falk A, Löf A, Hagberg M, Wigeaus Hjelm EW, Wang Z. Human exposure to 3-carene by inhalation: toxicokinetics, effects on pulmonary function and occurrence of irritative and CNS symptoms. *Toxicol Appl Pharmacol* 1991;110:198-205.
 84. Järnberg J, Johanson G, Löf A. Toxicokinetics of inhaled trimethylbenzenes in man. *Toxicol Appl Pharmacol* 1996;140:281-8.
 85. Järnberg J, Johanson G, Löf A, Ståhlbom B. Inhalation toxicokinetics of 1,2,4-trimethylbenzene in volunteers: comparison between exposure to white spirit and 1,2,4-trimethylbenzene alone. *Sci Total Environ* 1997;199:65-71.
 86. Järnberg J, Johanson G, Löf A, Ståhlbom B. Toxicokinetics of 1,2,4-trimethylbenzene in humans exposed to vapours of white spirit: comparison with exposure to 1,2,4-trimethylbenzene alone. *Arch Toxicol* 1998;72:483-91.
 87. Nihlén A, Löf A, Johanson G. Controlled ethyl tert-butyl ether (ETBE) exposure of male volunteers. I. Toxicokinetics. *Toxicol Sci* 1998;46:1-10.
 88. Nihlén A, Löf A, Johanson G. Experimental exposure to methyl tertiary-butyl ether. I. Toxicokinetics in humans. *Toxicol Appl Pharmacol* 1998;148:274-80.
 89. Nihlén A, Wälinder R, Löf A, Johansson G. Experimental exposure to methyl tertiary-butyl ether II. Acute effects in humans. *Toxicol Appl Pharmacol* 1998;148:281-287.
 90. Nihlén A, Löf A, Johanson G. Controlled ethyl tert-butyl ether (ETBE) exposure of male volunteers - II. Acute effects. *Toxicol Sci* 1998;46:143-150.
 91. SWEA. Provisions and General Recommendations. Ordinance AFS 2000:3. Swedish Work Environment Authority 2000;3.
 92. Rezvani AH, *2-Propanol*, in *Alcohols and Esters*, R.G. Thurman and F.C. Kauffman, Editors. 1992, Elsevier: Amsterdam. p. 31-37.
 93. IPCS. Environmental Health Criteria 52. Toluene. 1985;52.
 94. IPCS, *Environmental Health Criteria 190. Xylenes*. 1997.

95. Miller S, Dykes D, Polesky H. A simple salting out procedure for extracting DNA from nucleated cells. *Nucleic Acids Res.* 1988;16:1215.
96. Persson I, Johansson I, Bergling H, Dahl M-L, Seidegård J, Rylander R et al. Genetic polymorphism of cytochrome P4502E1 in a Swedish population. *FEBS Lett.* 1993;3193:207-211.
97. Hu Y, Hakkola J, Oscarson M, Ingelman-Sundberg M. Structural and functional characterization of the 5'-flanking region of the rat and human cytochrome P450 2E1 genes: Identification of a polymorphic repeat in the human gene. *Biochem Biophys Res Comm* 1999;2632:286-293.
98. Fritsche E, Pittman GS, Bell DA. Localization, sequence analysis, and ethnic distribution of a 96-bp insertion in the promoter of the human CYP2E1 gene. *Mutation Research Genomics* 2000;4321-2:1-5.
99. Fairbrother KS, Grove J, de Waziers I, Steimel DT, Day CP, Crespi CL et al. Detection and characterization of novel polymorphisms in the CYP2E1 gene. *Pharmacogenetics* 1998;86:543-552.
100. Carstensen U, Hou SM, Alexandrie AK, Högstedt B, Tagesson C, Warholm M et al. Influence of genetic polymorphisms of biotransformation enzymes on gene mutations, strand breaks of deoxyribonucleic acid, and micronuclei in mononuclear blood cells and urinary 8-hydroxydeoxyguanosine in potroom workers exposed to polyaromatic hydrocarbons. *Scand J Work Environ Health* 1999;254:351-60.
101. Chao YC, Wang MF, Tang HS, Hsu CT, Yin SJ. Genotyping of alcohol dehydrogenase at the ADH2 and ADH3 loci by using a polymerase chain reaction and restriction-fragment-length polymorphism in Chinese alcoholic cirrhotics and non-alcoholics. *Proc Natl Sci Counc Repub China B* 1994;183:101-6.
102. Brockmöller J, Gross D, Kerb R, Drakoulis N, Roots I. Correlation between trans-stilbene oxide-glutathione conjugation activity and the deletion mutation in the glutathione S-transferase class mu gene detected by polymerase chain reaction. *Biochem Pharmacol* 1992;433:647-650.
103. Tuominen R, Baranczewski P, Warholm M, Hagmar L, Möller L, Rannug A. Susceptibility factors and DNA adducts in peripheral blood mononuclear cells of aluminium smelter workers exposed to polycyclic aromatic hydrocarbons. *Arch Toxicol* 2002;763:178-86.
104. Droz PO, Wu MM, Cumberland WG, Berode M. Variability in biological monitoring of solvent exposure. I. Development of a population physiological model. *Br J Ind Med* 1989;467:447-60.
105. Beal SL, Sheiner LB, *NONMEM Users guides*, ed. E. (S. L. Beal and L. B. Sheiner. 1998, NONMEM Project Group. University of California at San Francisco, San Francisco.
106. Jonsson EN, Karlsson MO. *Xpose 2.0 User's Manual*. 1997: Uppsala University, Sweden.

107. Kjellberg A, Landström U, Löfstedt P, Wide P, Åkerlund E. Estimation of noise and annoyance in working environments. *Arbete och Hälsa* 1988;30:1-36.
108. Iregren A, Tesarz M, Wigaeus-Hjelm E. Human experimental MIBK exposure: effects on heart rate, performance, and symptoms. *Environ Res* 1993;631:101-8.
109. Forster RE, Fowler WS, Bates DV, Van Lingen B. The absorption of carbon monoxide by the lungs during breathholding. *J Clin Invest* 1954;332:1135-1145.
110. Cotes JE, Chinn DJ, Reed JW. Lung function testing: methods and reference values for forced expiratory volume (FEV1) and transfer factor (TL). *Occup Environ Med* 1997;547:457-65.
111. Gullstrand E, Sköldström B, Johanson M, Lundell T, Johanson G. Recording of blink frequency by computerised EMG analysis. in *ICOH*. 2000. Singapore.
112. Lanthony P. The desaturated panel D-15. *Doc Ophthalmol* 1978;461:185-9.
113. Cavalleri A, Belotti L, Gobba F, Luzzana G, Rosa P, Seghizzi P. Colour vision loss in workers exposed to elemental mercury vapour. *Toxicol Lett* 1995;771-3:351-6.
114. Frye RF, Adedoyin A, Mauro K, Matzke GR, Branch RA. Use of chlorzoxazone as an in vivo probe of cytochrome P450 2E1: choice of dose and phenotypic trait measure. *J Clin Pharmacol* 1998;381:82-9.
115. Bachmann K, Sarver JG. Chlorzoxazone as a single sample probe of hepatic CYP2E1 activity in humans. *Pharmacology* 1996;523:169-77.
116. Lucas D, Menez C, DuPont I, Bodenez P, Bardou LG, Berthou F. Clinical interest of the in vivo measurement of CYP2E1 in alcoholic liver diseases. *Alcohol clin exp Res* 1998;223:745-6.
117. Plee-Gautier E, Foresto F, Ferrara R, Bodenez P, Simon B, Manno M et al. Genetic repeat polymorphism in the regulating region of CYP2E1: frequency and relationship with enzymatic activity in alcoholics. *Alcohol Clin Exp Res* 2001;256:800-4.
118. Oneta CM, Lieber CS, Li J, Ruttimann S, Schmid B, Lattmann J et al. Dynamics of cytochrome P4502E1 activity in man: induction by ethanol and disappearance during withdrawal phase. *J Hepatol* 2002;361:47-52.
119. Desiraju RK, Renzi NLJ, Nayak RK, Kung-Tat N. Pharmacokinetics of chlorzoxazone in humans. *J Pharm Sci* 1983;729:991-994.
120. De Vries JD, Salphati L, Horie S, Becker CE, Hoener B-A. Variability in the disposition of chlorzoxazone. *Biopharm Drug Disposit* 1994;15:587-597.
121. Ogata M, Yamazaki Y, Sugihara R, Shimada Y, Meguro T. Quantitation of urinary o-xylene metabolites of rats and human beings by high performance liquid chromatography. *Int Arch Occup Environ Health* 1980;462:127-39.
122. Jones AW, Sagarduy A, Ericsson E, Arnqvist HJ. Concentrations of acetone in venous blood samples from drunk drivers, type-I diabetic outpatients, and healthy blood donors. *J Anal Toxicol* 1993;173:182-5.

123. Muttray A, Jung D, Rose D-M, Hommel G, Koneietzko J. Acute effects of exposure to 360 ppm isopropanol on healthy men. *J Occup Env Med* 1998;43:288-293.
124. Ernstgård L, Gullstrand E, Johanson G, Löf A. Toxicokinetic interactions between orally ingested chlorzoxazone and inhaled acetone or toluene in male volunteers. *Toxicol Sci* 1999;482:189-96.
125. Millqvist E, Bende M. Reference values for acoustic rhinometry in subjects without nasal symptoms. *Am J Rhinol* 1998;125:341-3.
126. Daly AK, Cholerton S, Gregory W, Idle JR. Metabolic polymorphisms. *Pharmacol Ther* 1993;572-3:129-60.
127. Stamatoyannopoulos G, Chen SH, Fukui M. Liver alcohol dehydrogenase in Japanese: high population frequency of atypical form and its possible role in alcohol sensitivity. *Am J Hum Genet* 1975;276:789-96.
128. Carriere V, Goasduff T, Ratanasavanh D, Morel F, Gautier J-C, Guillouzo A et al. Both cytochromes P450 2E1 and 1A1 are involved in the metabolism of chlorzoxazone. *Chem Res Toxicol* 1993;6:852-857.
129. Gorski JC, Jones DR, Wrighton SA, Hall SD. Contribution of human CYP3A subfamily members to the 6-hydroxylation of chlorzoxazone. *Xenobiotica* 1997;273:243-56.
130. Ono S, Hatanaka T, Hotta H, Tsutsui M, Satoh T, Gonzalez FJ. Chlorzoxazone is metabolized by human CYP1A2 as well as by human CYP2E1. *Pharmacogenetics* 1995;53:143-50.
131. Lucas D, Ferrara R, Gonzalez E, Bodenez P, Albores A, Manno M et al. Chlorzoxazone, a selective probe for phenotyping CYP2E1 in humans. *Pharmacogenetics* 1999;93:377-88.
132. Rose DM, Muttray A, Mayer-Popken O, Jung D, Konietzko J. Saliva as an alternate for blood to measure concentrations of acetone under exposure to isopropanol. *Eur J Med Res* 1999;412:529-32.